

**AECOM**



**AECOM**

# Wheatley

DESIGN GUIDANCE  
AND CODES

FINAL REPORT |  
February 2022



Delivering a better world

## Quality information

Name	Position	Action summary	Issue no.	Issue date
Qualifying Body	Wheatley Parish council	Final report	5	02.02.2022
Michelle Legg	Wheatley Parish council	Review	4	31.12.2021
Ben Castell	Director	Review	3	20.01.2022
Jessie Watson	Associate Director	Review, research	2	20.01.2022
Hoorieh Morshedi	Urban Designer	Research, site visit, drawings	1	20.01.2022
Chatnam Lee	Graduate Urban Designer	Research, drawings	0	17.12.2021

This document has been prepared by AECOM Limited ("AECOM") in accordance with its contract with Locality (the "Client") and in accordance with generally accepted consultancy principles, the budget for fees and the terms of reference agreed between AECOM and the Client. Any information provided by third parties and referred to herein has not been checked or verified by AECOM, unless otherwise expressly stated in the document. AECOM shall have no liability to any third party that makes use of or relies upon this document.

# Contents

<b>01</b>	<b>1. Introduction</b>	<b>5</b>	<b>04</b>	<b>4. Village character assessment</b>	<b>41</b>
	1.1 About this report	5		4.1 Defining the character areas	41
	1.2 Aims and objectives	5		4.2 Defining the areas for coding	61
	1.3 Process and engagement	5			
	1.4 Document structure	6			
	1.5 Area of study	7			
<b>02</b>	<b>2. Policy and evidence based review</b>	<b>12</b>	<b>05</b>	<b>5. Design guidance and codes</b>	<b>64</b>
	2.1 Introduction	12		5.1 Introduction	64
	2.2 Key policy and guidance	16		5.2 When to use the codes	65
				5.3 How to apply the design guidelines and codes	67
				5.4 Design guidelines	68
				5.5 Specific design codes	91
<b>03</b>	<b>3. NP Area context analysis</b>	<b>21</b>	<b>06</b>	<b>6. Checklist</b>	<b>115</b>
	3.1 Introduction	21		6.1 General questions to ask when presented with a development proposal	115
	3.2 Village history	22			
	3.3 Statuary designations	23			
	3.4 Heritage designations	25			
	3.5 The sense of community	28			
	3.6 Route pattern and connectivity	30			
	3.7 Landscape setting and green space	32			
	3.8 Setting and figure ground	35			
	3.9 Towncape	37	<b>07</b>	<b>7. Delivery</b>	<b>124</b>
				7.1 Delivery	124

Introduction

# 01



# 1. Introduction

## 1.1 About this report

The Parish of Wheatley have established a Neighbourhood Plan Steering Group (NPSG) in order to shape and influence development within their area. The Neighbourhood Plan was made in May 2021. The Design Code is being prepared as part of the first review of that plan. Locality is the national membership network for community organisations that brings local people together to produce Neighbourhood Plans. Through Locality's support programme, AECOM have been appointed to prepare this Design Code document which will form part of the evidence base for their new Neighbourhood Plan on behalf of Wheatley Parish Council.

## 1.2 Aims and objectives

The purpose of this document is to provide an appreciation of Wheatley Village's existing character in order to create a set of design codes which will apply to any future housing development in the village. This will help to ensure that as any new development comes forward, it responds to its context and supports and enhances the quality of the villages' existing character.

AECOM

## 1.3 Process and engagement

Following an inception meeting, AECOM and the members of Wheatley Parish Council carried out a high-level assessment of the village. The following steps were agreed with the group to produce this report:

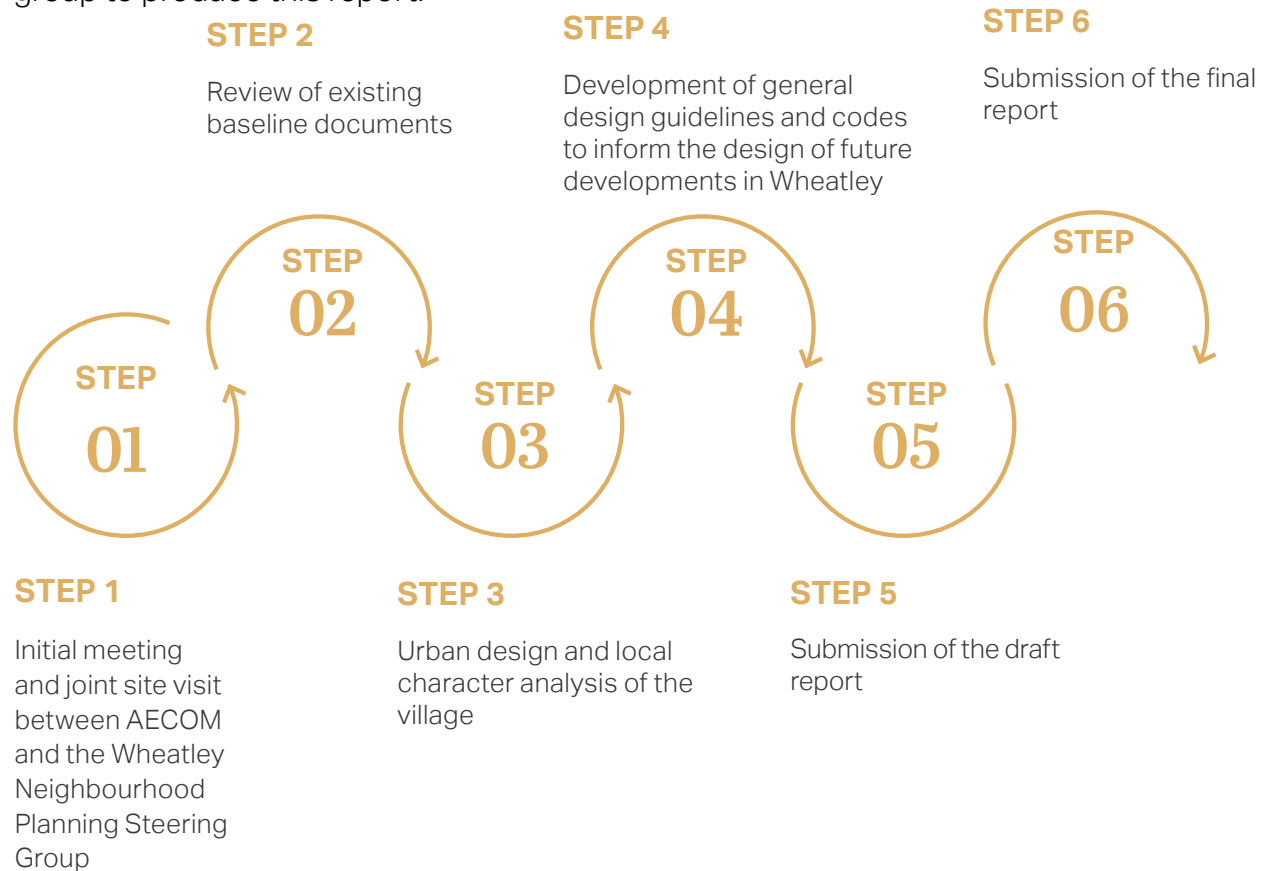

**F.1** **Figure 01:** Key steps involved in the development of the Wheatley Neighbourhood masterplanning and design guidance

## 1.4 Document structure

**01 INTRODUCTION** - Outlining the background, purpose, process, study area and design code document structure.

**02 POLICY REVIEW** - Reviewing the planning policy context.

**03 NEIGHBOURHOOD AREA CONTEXT ANALYSIS** Provides an appreciation of physical influences which will be used to help inform the design codes.

**04 VILLAGE CHARACTER ASSESSMENT**  
A focused understanding of the parishes' built and natural landscape character is provided by undertaking a photographic survey to analyse key characteristics.

**05 DESIGN GUIDANCE AND CODES** -  
The design codes to be applied to future developments in the Neighbourhood Area are established.

**06 CHECKLIST** - This chapter provides a number of questions based on established good practice against which the design proposal should be evaluated.

**07 NEXT STEPS** - Next steps for the NPSG and potential future developers.



**F.2** Figure 02: A view from Church of St Mary's to Church Road

## 1.5 Area of study

### SOUTH OXFORDSHIRE

South Oxfordshire is an exceptionally beautiful area, rich in architecture of different periods, styles and materials with almost half of the district designated as an Area of Outstanding Natural Beauty. As well as respecting and enhancing the existing natural and built environment of South Oxfordshire, the Council expects the design of new development to be similarly outstanding for the benefit of local residents, visitors and future generations. South Oxfordshire has been named the best place to live in the UK countryside in 2016.

The district of South Oxfordshire covers nearly 670km<sup>2</sup>. Its boundaries reach from the edge of the city of Oxford in the north west along the borders of Buckinghamshire and Berkshire to the outskirts of Reading in the south. It has four main towns: Didcot, Henley, Thame and Wallingford, with Didcot becoming increasingly dominant as the main urban centre.

Much of the district is predominantly rural in nature, with most of the land being in agricultural use. The main exception to this is the south east where the wooded Chiltern Hills rise sharply from the Thames Valley. Most of the southern end of the district sits in either of the Chilterns or North Wessex Downs Area of Outstanding Natural Beauty (AONB). The north east of the district forms part of the Oxford Green Belt. In total, around 70% of the district has a Green Belt or AONB designation.

Several registered parks and gardens surround the village, which are described in more detail in Chapter 3: Local Context.

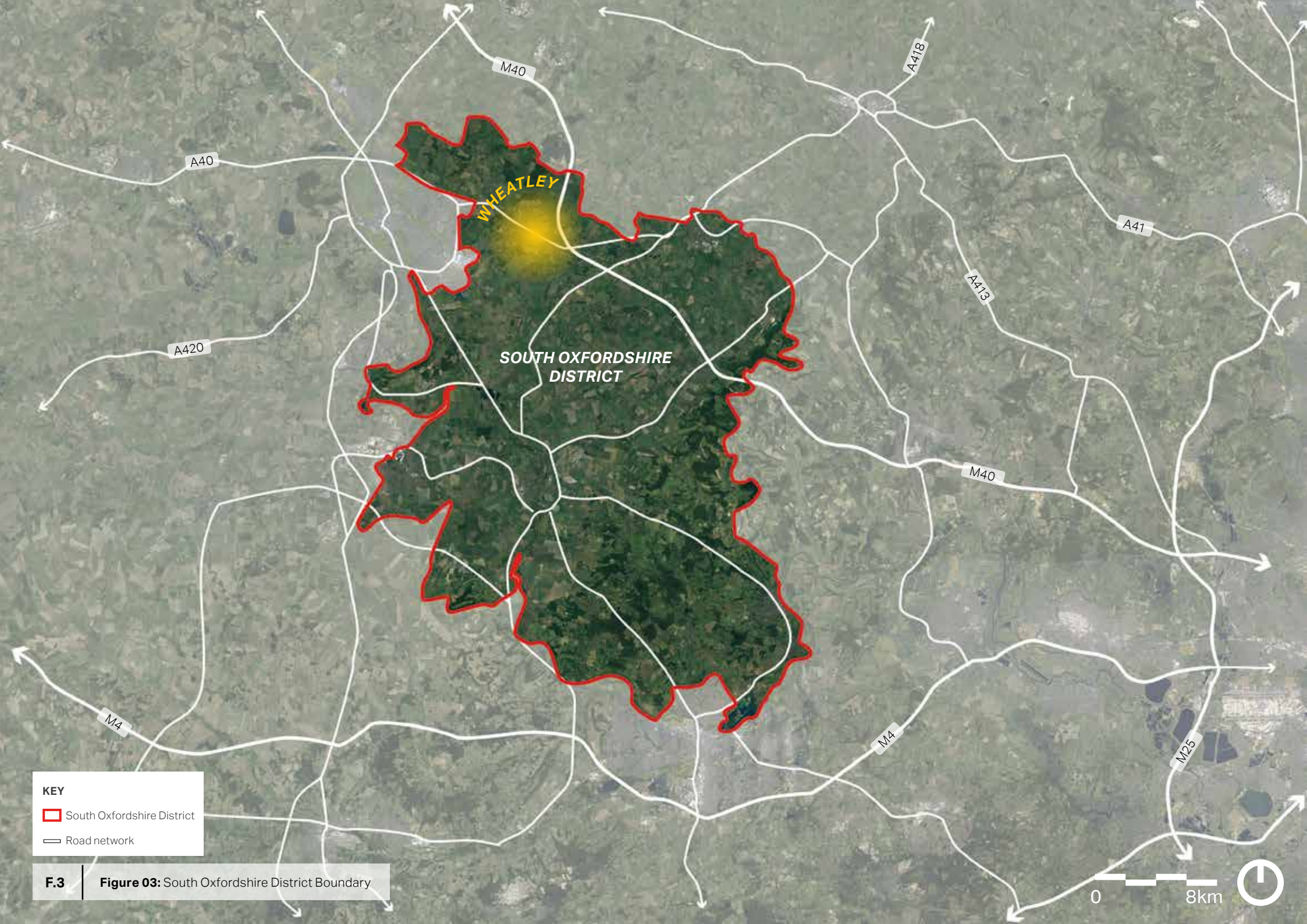

**KEY**

- South Oxfordshire District
- Road network

**F.3** | **Figure 03:** South Oxfordshire District Boundary

0 8km



## THE PARISH OF WHEATLEY

Wheatley is a village and civil parish in Oxfordshire, located approximately five miles to the east of Oxford. It is located to the south of the A40 and to the west of the M40. The River Thame abuts the eastern edge of the village. The parish includes the hamlet of Littleworth, which is immediately to the west of Wheatley village.

Its morphology is linear, with the footprint of the village extending approximately two miles. It is in a valley running eastwards, the stream of which flows through the centre of the village to join the River Thame, a tributary of the River Thames.

The South Oxfordshire Local Plan categorises Wheatley as a 'Larger Village' and Littleworth as a 'Smaller Village'.

The 2011 census recorded the parish population as 3,913.



F.4



F.5

**Figure 04:** A two-storey detached house on High Street

**Figure 05:** Church of St Mary's on Church Road

**Figure 06:** Wheatley Parish Office and merry Bells on High Street

**Figure 07:** Semi-detached house with well-kept front garden on The Avenue



F.6



F.7



**KEY**

- Wheatley Neighbourhood Area boundary
- Waterbodies
- Road network

**F.8** | **Figure 08:** Wheatley Neighbourhood Plan Area within the context

0 200 1km

**Policy and evidence  
based review**

**02**



# 2. Policy and evidence based review

## 2.1 Introduction

This section summarises the relevant design policy, guidance and evidence base produced at national, county and district levels which have informed this design code. Any new development application should be familiar with those documents.

02

National Design Guidance

**2021**



**National Planning Policy Framework -** Department for Levelling Up, Housing and Communities

Relevant national planning policy is contained within the National Planning Policy Framework (NPPF, July 2021). The NPPF was updated in July 2021 to include reference to the National Design Guide and National Model Design Code and the use of area, neighbourhood and site-specific design guides. Paragraph 126 states that: "the creation of high quality buildings and places is fundamental to what the planning and development process should achieve and outlines that good design is a key aspect of sustainable development, creates better places in which to live and work and helps make development acceptable to communities."

Householders have a wide range of permitted development rights to extend their homes, such as the ability to extend their homes up to 50% of the curtilage of the original house. Back garden land has been given added protection in the NPPF when it was reclassified from brownfield to formerly undeveloped land. However, the NPPF makes it clear that the key consideration should be whether back garden development would harm local character.

**2021**



**National Design Guide -** Department for Levelling Up, Housing and Communities

The National Design Guide sets out the government's ten priorities for well designed places and illustrates how well-designed places can be achieved in practice. The ten characteristics identified includes: context, identity, built form, movement, nature, public spaces, uses, homes and buildings, resources and lifespan. The Guide also reinforces the National Planning Policy Framework's objective in creating high quality buildings and places. The document forms part of the government planning practice guidance.

2021



**National Model Design Code** - Department for Levelling Up, Housing and Communities

The draft National Model Design Code provides guidance on the production of design codes, guides and policies to promote well-designed places. It sets out the key design parameters that need to be considered when producing design guides and recommends methodology for capturing and reflecting views of the local community.

2015



**Building Regulations 2010** - Homes England

This approved document provides guidance on how to comply with requirement Q1 of the building regulations. The requirement Q1 applies to easily accessible doors and windows that provide access in various circumstances.

2020



**Building for a Healthy Life** - Homes England

Building for a Healthy Life updates Homes England's key measure of design quality as the national housing accelerating body. The document sets out 12 considerations for creating integrated neighbourhoods distinctive places and streets for all. While it is not part of the national policy, it is recognised as best practice guidance and design tool in assessing the design quality of developments.

None



**Planning Portal on extensions/ modification**

The Planning Portal defines infill development as 'The development of a relatively small gap between existing buildings.' ([https://www.planningportal.co.uk/directory\\_record/3Q5/infill\\_development](https://www.planningportal.co.uk/directory_record/3Q5/infill_development))

National Design Guidance

2007



**Manual for Streets** - Department for Transport

Development is expected to respond positively to the Manual for Streets, the Government's guidance on how to design, construct, adopt and maintain new and existing residential streets. It promotes streets and wider development that avoid car dominated layouts but that do place the needs of pedestrians and cyclists first.

Local Policy

2020



**South Oxfordshire Local Plan 2011 - 2035**

South Oxfordshire District Council adopted their Local Plan (a blueprint for development up until 2035) in December 2020. The Local Plan defines Wheatley as a 'Larger Village' within the district. Wheatley is the only Larger Village in the borough which is inset from the Green Belt where a Neighbourhood Development Plan is being prepared. There is one strategic housing allocation for approximately 500 homes in the Local Plan within Wheatley: STRAT14: Land at Wheatley Campus, Oxford Brookes University.

Policy H16: Backland and Infill Development and Redevelopment, provides some general guidance on infill development, covering matters such as scale, privacy and access.

2016



**South Oxfordshire Design Guide**

South Oxfordshire District Council adopted the Design Guide in 2016, which is a Supplementary Planning Document that provides guidance for design standards of developments delivered across South Oxfordshire. All planning applications are required to test their proposals and demonstrate consistency with the design principles set out in the Design Guide - which will be used by the council to assess proposals.

The Design Guidance cover parameters such as density and uses, street network and design, scale and massing, parking solutions as well as public realm.

**Out for consultation**



**Joint Design Guide**

South Oxfordshire and the Vale of White Horse District Councils' have prepared a Joint Design Guide, which is currently out for consultation. The Guide, when adopted, will become a Supplementary Planning Document, and will replace the previous South Oxfordshire Design Guide. The Guide provides guidance on how new development should be designed and constructed to the highest quality and includes a number of overarching key design objectives along with more specific design principles, covering place and setting; natural environment; movement and connectivity; space and layout; built form; climate and sustainability. The Design Guide provides valuable high level District guidance, which this local Design Code will complement.

**2010**



**Chilterns Design Guide**

The task of the Chilterns Conservation Board is to ensure the special qualities of the Area of Outstanding Natural Beauty (AONB) are conserved and enhanced. The first edition of the Chilterns Buildings Design Guide (published in 1999) provided guidance about the erection of new buildings and the extension and conversion of older ones.

The Design Guide has been supplemented by a series of Technical Notes on the use of flint, brick and roofing materials in the Chilterns. In addition environmental guidelines for the management of highways in the Chilterns have been produced.

**2021**



**Wheatley Neighbourhood Plan (WNP)**

The emerged Neighbourhood Plan for the parish of Wheatley has been prepared by the communities of Wheatley and Holton. The WNP sets out the community vision for the future of the area during the plan period (2019 - 2034), together with providing a land use framework for development in the area, which will be achieved through a series of objectives and policies.

## 2.2 Key policy and guidance

### SOUTH OXFORDSHIRE LOCAL PLAN 2011 - 2035

Policy H16 Policy H16: Backland and Infill Development and Redevelopment, provides some general guidance on infill development, as follows:

- Within Smaller Villages and Other Villages, development should be limited to infill and the redevelopment of previously developed land or buildings;
- Infill development is defined as the filling of a small gap in an otherwise continuous built-up frontage or on other sites within settlements where the site is closely surrounded by buildings. The scale of infill should be appropriate to its location;
- Where a proposal encompasses residential development of land behind an existing frontage or placing of further dwelling/s behind existing dwelling/s within the existing site, the proposals should demonstrate that:
  1. The privacy of existing and future residents will be protected;

2. Means of access can be appropriately secured; and
3. Development would not extend the built limits of the settlement.

The development of large back gardens or land behind an existing residential frontage may be acceptable in principle if it meets the criteria in the above policy. However, such development will not normally be permitted if it creates problems of privacy and access.

Policy STRAT5: Residential Densities provides guidance on appropriate densities, as follows:

- The density of a development should be informed by:
  - i) the capacity of the site and the need to use land efficiently in accordance with Policy DES7: Efficient use of resources;
  - ii) the need to achieve high quality design that respects local character;
  - iii) local circumstances and site

constraints, including the required housing mix, and the need to protect or enhance the local environment, Areas of Outstanding Natural Beauty, heritage assets, and important landscape, habitats and townscape;

iv) the site's (or, on strategic allocations, the relevant part of the sites's) current and future level of accessibility to local services and facilities by walking, cycling and public transport; and

v) the need to minimise detrimental impacts on the amenity of future and/or adjoining occupiers.

- It stipulates that a net density of 45dh is appropriate when it is consistent with the settlement it relates to (in Sites well related to existing towns and villages and served by public transport or with good accessibility by foot or bicycle to the town centres of Didcot, Henley, Thame and Wallingford or a district centre within Oxford City.



- The design of a site needs to pay careful attention to the existing character of a local area and any local circumstances, taking account of a range of social and environmental constraints, accessibility and amenity issues.

## PLANNING ENFORCEMENT

The enforcement team within SODC maintain the integrity of the planning system and planning decisions made by the councils by investigating allegations of breaches of planning control, and then where appropriate, taking effective action in the public interest where unacceptable planning harm is identified. With specific regard to infill development, the enforcement team cannot take formal action against the following scenarios:

- Building work that had been completed for more than 4 years, unless it's a listed building;
  - A material change of use of land that has been continuous for more than 10 years;
  - A breach of a condition of a planning approval that has been breached for more than 10 years; and
  - A new dwelling built without planning permission after 10 years.
- In addition, and in respect of infill development issues, the following scenarios cannot be considered by planning enforcement, as they are not planning issues:
- Obstruction of a highway or public right of way (dealt with by Oxfordshire County Council / the police);
  - Parking of commercial or other vehicles on the highway in residential areas or on grass verges (dealt with by Oxfordshire County Council / the police);
  - Parking a caravan within the curtilage of a residential building provided its use is incidental or ancillary to the main dwelling;
  - Trespass / deeds and covenant restrictions / boundary disputes (these are private, civil matters and should be dealt with by a solicitor, or the Citizens Advice Bureau);
  - Clearing land of hedges, bushes or undergrowth (Unless subject to Ancient Hedgerows Regulations 1997);
  - Internal works to a non-listed building (Structural works may be subject to building control regulations);
  - Insertion of additional windows in residential dwellings (once a building has been occupied windows may be inserted into existing walls provided there is not a planning condition to prevent the insertion of additional windows, or a restriction set by permitted development rights); and
  - Health and safety issues including noise and activity on building sites (dealt with the Health and Safety Executive).

## WHEATLEY NEIGHBOURHOOD PLAN (WNP)

The Neighbourhood Plan for the parish of Wheatley was made in 2021. It has been prepared by the communities of Wheatley and Holton. The WNP sets out the community vision for the future of the area during the plan period (2019 - 2034), together with providing a land use framework for development in the area, which will be achieved through a series of objectives and policies. The designated area of the Neighbourhood Plan is shown on Figure 08.

In addition to enabling communities to decide where new development should go, one of the key purposes of neighbourhood planning is to enable local communities to say what new development should look like.

The WNP provides an overview of the village, along with a summary of its key characteristics along with policies on housing, infrastructure, the environment and the local economy.

The relevant overarching design policy is 'Policy H1: Design and Character Principles', which is listed below.

Development proposals will be supported, provided they complement, enhance and reinforce the local distinctiveness of the village and where appropriate are designed to enhance the setting of the conservation area and its settings. Proposals must show clearly how the scale, mass, density, layout and design of the site, building or extension fits in with the character of the immediate area and wider context within the village.

The development proposals will be supported if they respond positively to the following principles as appropriate to their scale, nature and location with the neighbourhood area:

- Provides a high-quality of internal and external living space;
- Has regard to historic plot boundaries, hedgerows and enclosure walls;
- Proposals for new garages, outbuildings or tall garden walls must be subservient in scale and, whether of a traditional or modern design, should draw from the local palette of vernacular building materials;
- The impacts on residential amenity of the construction arrangements are minimized by way of lorry movement, deliveries, work times, lighting and loss of vegetation;
- The layout, orientation and massing of new houses on larger residential schemes must avoid an estate-style appearance by dividing the developable area into distinct parcels and by responding to the historic grain of the development in the village, including its road and footpath network and historic property boundaries;

- They use permeable surfaces on driveways and use sustainable drainage systems that can connect directly to an existing or new wet environment wherever possible;
- They will not require culverts for the existing ditches, unless there is a demonstrable benefit to walking, cycling, highway safety or access;
- The layout maximises the opportunities for open space and recreation facilities
- The layout provides a high-quality landscape scheme; and
- The proposals should incorporate where possible walking and cycling routes, and where possible, enhance and connect existing walking and cycling routes.

Appendix 1 of the WNP sets out more detail on the history and character of the village, along with some information on the architectural character.

## **SOUTH OXFORDSHIRE DESIGN GUIDE**

The South Oxfordshire Design Guide 2016 Supplementary Planning Document is for designers, developers, officers, councillors and the public and sets out the Council's expectations for high quality design in developments and how to achieve this. The guide is broken down into three sections and includes technical documents focusing on disciplines such as landscape, biodiversity, trees, public art, conservation, and sustainable energy. The parts of the report are summarised below:

### **PART 1**

An overview of South Oxfordshire and some general guidance on the guide and how to use it.

### **PART 2**

A number of overarching design principles that cover good urban design practice, including contextual analysis, site concept, connectivity and street design, block principles, definition and enclosure, open space. Along with more detailed design guidance on street furniture, lighting, public art, parking, plot design, maintenance and management and design quality.

### **PART 3 – TECHNICAL DOCUMENTS**

The design guide is accompanied by a suite of technical documents focusing on disciplines such as landscape, biodiversity, trees, public art and sustainable energy. The technical documents also focus on other types of development such as non-domestic buildings, apartments, householder extensions and outbuildings, building conversions, shopfronts and signage.

This document will be replaced by the South Oxfordshire and Vale of White Horse District Councils' Design Guide, when adopted.

### **CHILTERN'S DESIGN GUIDE**

The Chilterns Buildings Design Guide contains practical advice for planners, architects and house owners on how to build or restore properties in keeping with the special qualities of the Chilterns AONB. It covers such topics as the setting of buildings, the design of vernacular features and the use of traditional local materials.

NP Area context  
analysis

03



# 3. NP Area context analysis

## 3.1 Introduction

This chapter describes the local context and key characteristics of Wheatley village. It is important that all development proposals in Wheatley, whether big or small are based on an understanding of the context of the village. Development proposals should clearly demonstrate an understanding of that context and how it has been addressed in the preparation of the design and any related planning submissions. Context refers to the current (and sometimes future) conditions within an area across a range of issues including village history and heritage, morphology, green space, movement and landscape setting. The following pages in this section consider these matters, in the context of Wheatley, in more detail.

We have undertaken a character assessment of the village of Wheatley and our findings have a number of key features, which can be summarised as follows.

03  
—



F.9

**Figure 09:** The row of timber framed housing on London Road looking east in 1930s (Courtesy of Wheatley Village Archive)



F.10

**Figure 10:** The circular structure which was part of a water fountain, disappeared after an accident during one Guy Fawkes night in 1930s (Courtesy of Wheatley Village Archive)



F.11

**Figure 11:** A historic image showing one of the dwellings on The Avenue in 1930s (Courtesy of Wheatley Village Archive)

### 3.2 Village history

The village has its origins in Roman times, with Stone and Iron Age settlements also present. The village then formed a royal Saxon estate centred on Cuddesdon. The village became a parish in 1856 and since then has seen gradual expansion over the 19th and 20th centuries. As the village has expanded over time, the buildings have reflected the times in which they were built.

Wheatley has a wealth of attractive, historic buildings. The photographs on the next page are a small selection of some of the timber fronted residential buildings within the area which contribute to the historic character of the village.

More recently, some of individual infill and replacement dwellings, although different, have added interest and variety without overwhelming the essential character of the place. More recently estate building has detracted from this character. For example, the 1960 developments by the Pye Group,

based on long uniform height terraces with white cladding, now seem incongruous; the development at Howe Close with its low pitched roofs and buff brick does not reflect its surroundings, and the development at Barlow Close with mono pitch roofs seems to sit uncomfortably beside the road leading up to Shotover Park.

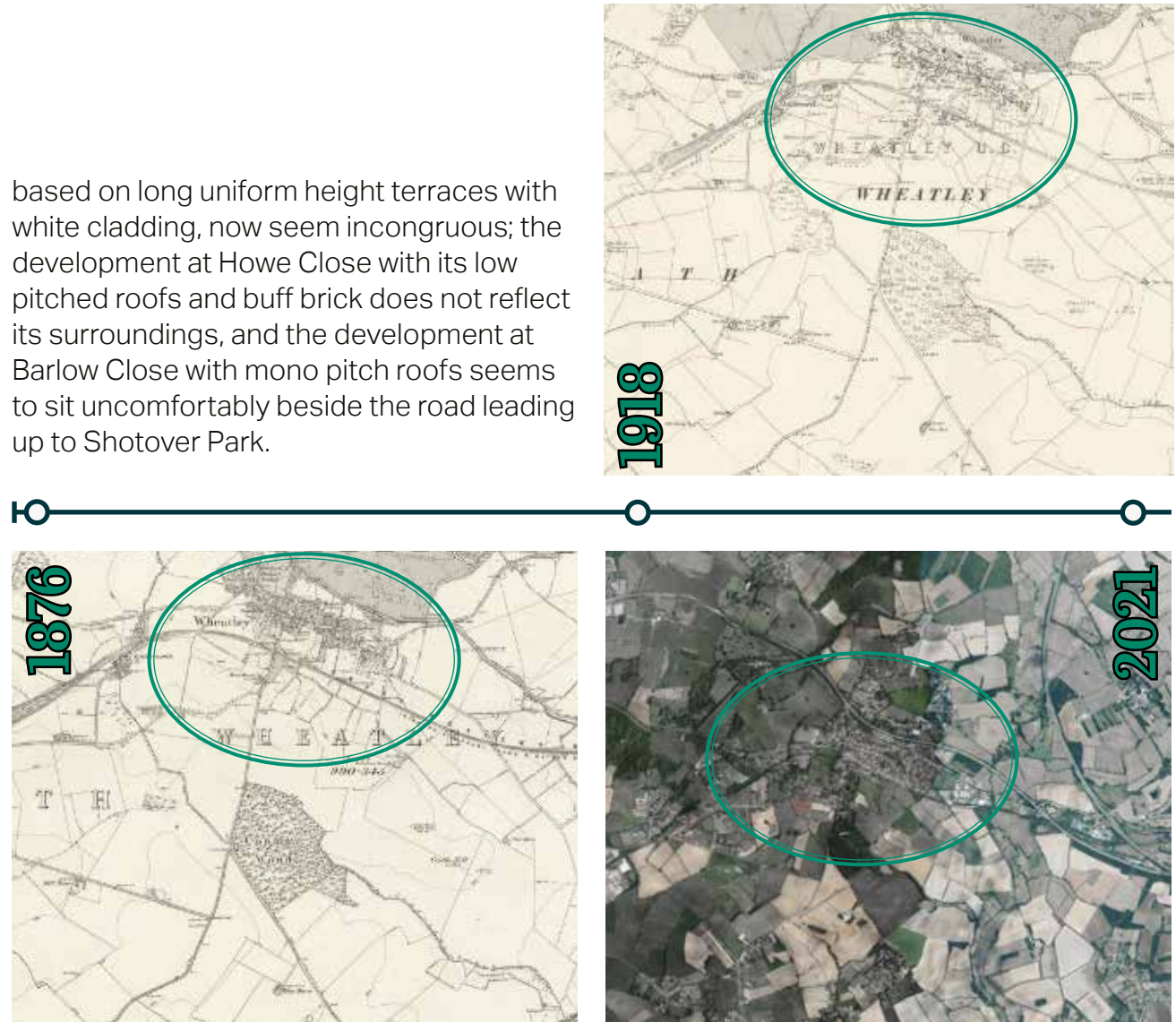

F.12

Figure 12: Historic mapping of the village

### 3.3 Statutory designations

The Green Belt boundary abuts the edge of the settlement.

There are a great many number of trees within the village that are protected by a Tree Preservation Order. The majority of these are to the north of Church Road, and to the north of the A40 around the Wheatley Campus.

Beyond the Neighbourhood Plan boundary, there are a number of statutory

designations, including:

- Shotover Registered Park and Garden;
- Shotover Country Park;
- Brasenose Wood and Shotover Hill SSSI and Littleworth Brick Pit SSSI;
- Coombe Wood – Ancient Woodland;
- A drift of woodland to the east of Holton Village Hall – Ancient woodland; and
- Moated site of Holton House and its associated ice house – Scheduled Ancient Monument.



F.13

**Figure 13:** Presence of lime tree in front garden of semi-detached dwellings on London Road (Courtesy of Wheatley Village Archive)



F.14

**Figure 14:** View towards woodland around Holton Village Hall



**KEY**

- Wheatley Neighbourhood Area boundary
- Conservation area
- Scheduled Monument
- Registered Parks and Gardens
- Site of Special Scientific Interest (SSSI)
- Tree Preservation Orders (TPO)
- Green Belt
- Woodlands
- Ancient Woodland
- Built-up area
- Waterbodies
- Road network

© Crown copyright and database rights 2020 Ordnance Survey 100043392

**F.15** | **Figure 15:** Statutory designations map

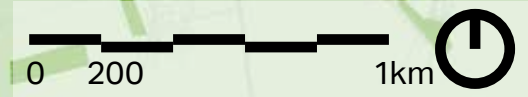



## 3.4 Heritage designations

From medieval times the village focused on agriculture and quarrying which survived well into the beginning of the 20th century. Most of the original houses in the village were built from local stone, many of which are still standing, and contribute towards the village's strong, consistent character.

Within the village itself, the Conservation Area (established in 1989) encompasses almost the entire spine of the historic central valley, running along the High Street from Kiln Lane to the west to Crown Road in the east. A number of buildings are included to the north of Church Road and it also includes the pond field to the north of Littleworth Road and east of the Primary School, as well as a large area of open space behind the Manor House.

Wheatley has a number of locally distinctive buildings including 55 listed buildings and two Scheduled Ancient Monuments (SAMs) within the Conservation Area, which contribute towards the village's strong sense of place.

### Scheduled Ancient Monuments

- **Moated Site of Holton House and its associated ice house** (List Entry Number (LEN) 1018424), which lies within the former grounds of Holton Park. The moat is believed to have been built in the late medieval period, to provide a more impressive setting for the manor house. The manor house had previously occupied a smaller moated site 280m to the south east which is the subject of a separate scheduling.
- **Moated Site 580m south west of Church Farm** (LEN: 1018425). The circular moat 580m south west of Church Farm is believed to form the earthwork remains of the earliest Holton Manor, a small manor house with associated buildings situated on a moated island with open views in all directions. Such early manorial settlements were functional and sometimes defensive rather than comfortable or luxurious.

### Listed buildings

- **Church of St Mary's** (LEN: 1284661) is a Grade II\* listed building built in mid 19th century. The materials used in the building are squared limestone with ashlar dressings. Its notable features are a 3 bay aisled nave, a chancel with a 2 bay north aisle and the west tower and south porches
- **The King and Queen Public House** (LEN: 1047447) which is a Grade II listed building. The pub was built in the late 16th century and remodelled mid 18th century. It was constructed by squared coursed limestone rubble and ashlar dressings, plain tile roof and brick stacks;
- **The Lock Up** (LEN: 1047479) is a Grade II listed building which was built in 1834. It has a hexagonal pyramid plan with heavy plank door with stone lintel. Squared coursed limestone rubble is used in the structure; and
- **The King's Arms Public House** (LEN: 1047480) is a Grade II listed building which was built in 1756. This two-storey building has a 4-pane sash window and at the rear there are several gabled and hipped wings of one-storey plus attics with 2-panelled shutters.

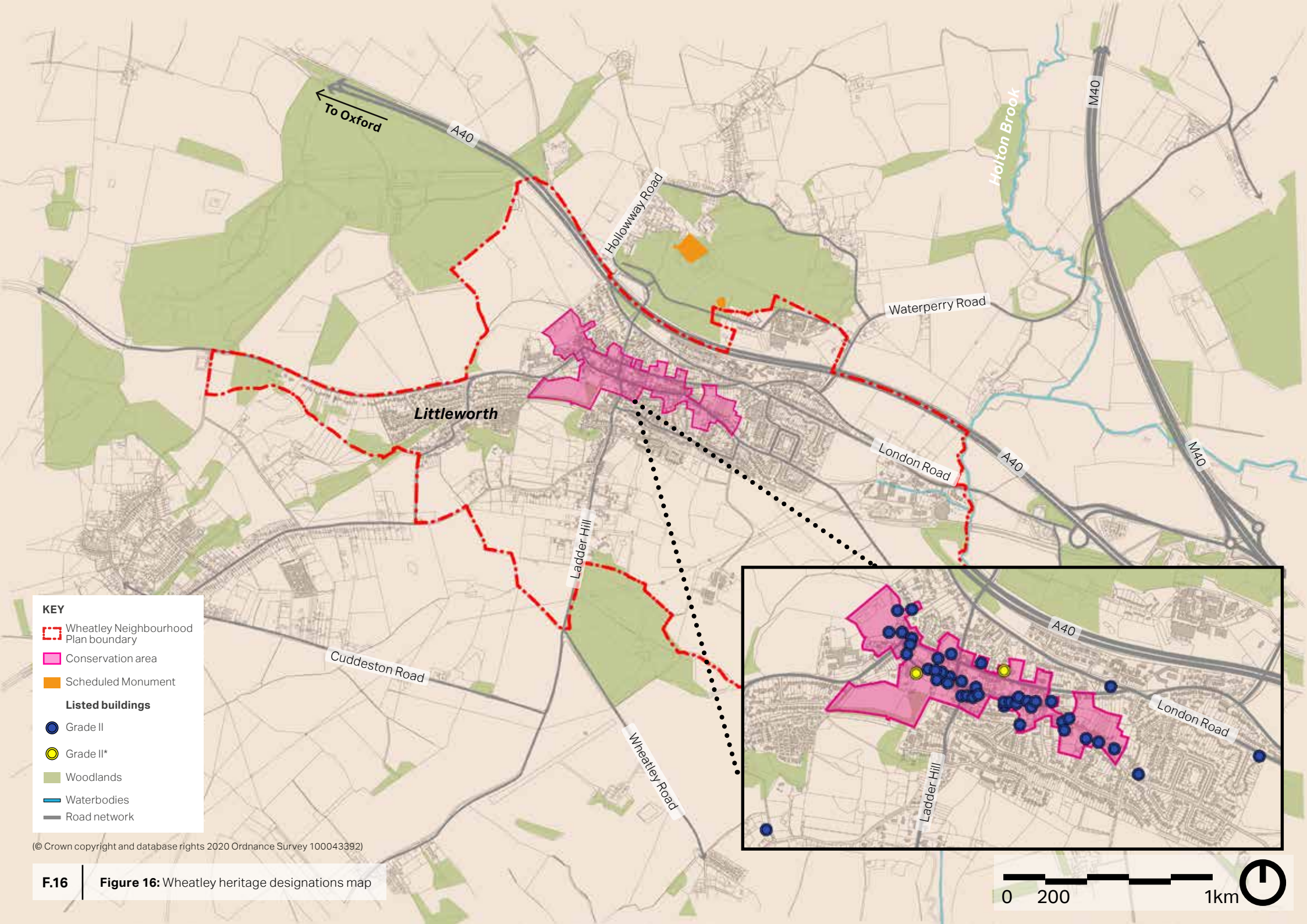

**KEY**

- Wheatley Neighbourhood Plan boundary
- Conservation area
- Scheduled Monument
- Listed buildings**
- Grade II
- Grade II\*
- Woodlands
- Waterbodies
- Road network

© Crown copyright and database rights 2020 Ordnance Survey 100043392

**F.16** | **Figure 16:** Wheatley heritage designations map

0 200 1km

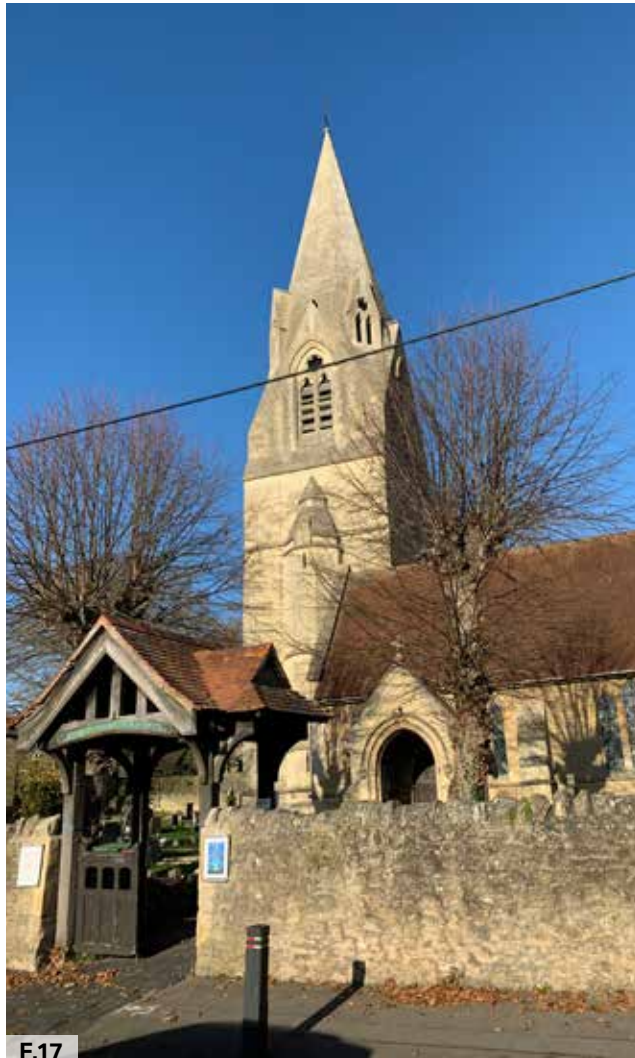

F.17



F.18

**Figure 17:** Church of St Mary's, a Grade II\* listed building built in mid 18th century. There are some views toward the church from different parts of the Parish

**Figure 18:** The Lock-Up is a II listed building built with limestone rubble on Church Road

**Figure 19:** The Kings Arms Public House is a Grade II listed building located at the junction of Church Road and London Road (Courtesy of Wheatley Parish Council)



F.19

### 3.5 The sense of community

As set out in the Neighbourhood Plan, there is a strong feeling of identity among the residents of Wheatley. Wheatley has a heritage of community spirit and participation in local life, including having a voice on issues of new local development.

This is in part, influenced by its rural setting within the beautiful Green Belt countryside, and its convenient access to the many different areas of open space and woodland within and surrounding the village, which, as set out the landscape setting section of this chapter, helps to create opportunities for residents to connect with each other, enhancing their physical and mental well-being

Alongside this, there is a rich history of benevolence in the village, owing to a number of elements. The four 'homes fit for heroes' were Government subsidised homes built by WUDC on Church Road in 1921/2. Post WWI, a 'Garden Estate', was constructed, which consisted of a further 50 subsidised homes. These homes were

intended to raise tenant pride and were founded on the philosophy that close proximity with the natural environment benefits residents' health and well-being. They were also constructed with health and well-being in mind, with the following notable design elements incorporated into the design of the homes:

- Designed with natural daylight in mind, with generous windows front and back;
- Constructed using high quality materials;
- Each home had a Lime Tree planted alongside it, as well as a Hawthorne hedge boundary with clover for animal grazing;
- Fences between houses was limited, to prevent division and separation;
- Homes were – originally – surrounded by open fields; and
- Houses were set at angles so that residents could interact easily and to encourage overlooking.



**Figure 20:** The Old Bank, now being used as a shop and Post Office on the High Street

**Figure 21:** Wheatley Play Area on Church Road

**KEY**

 Wheatley Neighbourhood Area boundary

 Woodlands

 Tree Protection Order

 Play Area

**Public Right of Ways (PRoWs)**

 Footpaths

 Bridleways

**Landmarks and Community Amenities**

① The Cricketers

② Wheatley Windmill

③ The Aunties Old School Nursery

④ Wheatley CofE Primary School

⑤ Wheatley Post Office

⑥ The Sun Cafe + Bar

⑦ Morland House Surgery

⑧ The King & Queen

⑨ Tripp Hearing

⑩ Parish Church of St Mary's the Virgin Wheatley

⑪ The Merry Bells (Parish Hall)

⑫ Wheatley Dental Practice

⑬ Wheatley United Reformed Church

⑭ The Kings Arms

⑮ Triangle Care Home

⑯ The Plough



### 3.6 Route pattern and connectivity

Wheatley is located approximately five miles to the east of Oxford. The village is accessible from the A40/M40 junction, via London Road. The A40 connects into the M40 to the east and to Oxford to the west.

The streets in the village are mixed in character, comprising the historic routes within the Conservation Area, such as the High Street and Church Road, alongside a number of secondary residential roads and a number of clusters of cul-de-sac access streets and estates, particularly to the north of Church Road and in Littleworth. The primary route through the village in terms of hierarchy is London Road which connects the main village to the A40 and north to Wheatley Park School and the Oxford Brooks campus. The High Street is the historic linear route which runs through the centre of the village.

There are several regular bus services in Wheatley (280, U1, 275, 46) providing access to Oxford, Tiddington, Thame, Haddenham and Aylesbury.

A number of public rights of way connect the village with the Chilterns countryside beyond and provide good walking routes within the village itself. The Oxford Greenbelt Way runs through Horspath to the west of the village, providing a national route to Shotover Country Park and Oxford and the hilltop village of Garsington. Several areas of woodland, such as Coombe Wood, Stanton Great Wood and Holton Woods are accessible by footpaths and bridleways.

National Cycleway (57) runs through the centre of the village along Church Road, linking up with Thame to the east and Oxford to the west.

Car parking is an issue in the village, particularly along Church Road, Park Hill, Littleworth Road and London Road. There are parking restrictions on the High Street (2 hours), but they are not always enforced.



F.23



F.24

**Figure 23:** The High Street, one of the main roads in Wheatley runs to the village centre

**Figure 24:** Old Road in Littleworth, a tertiary road with narrow footpath on one side

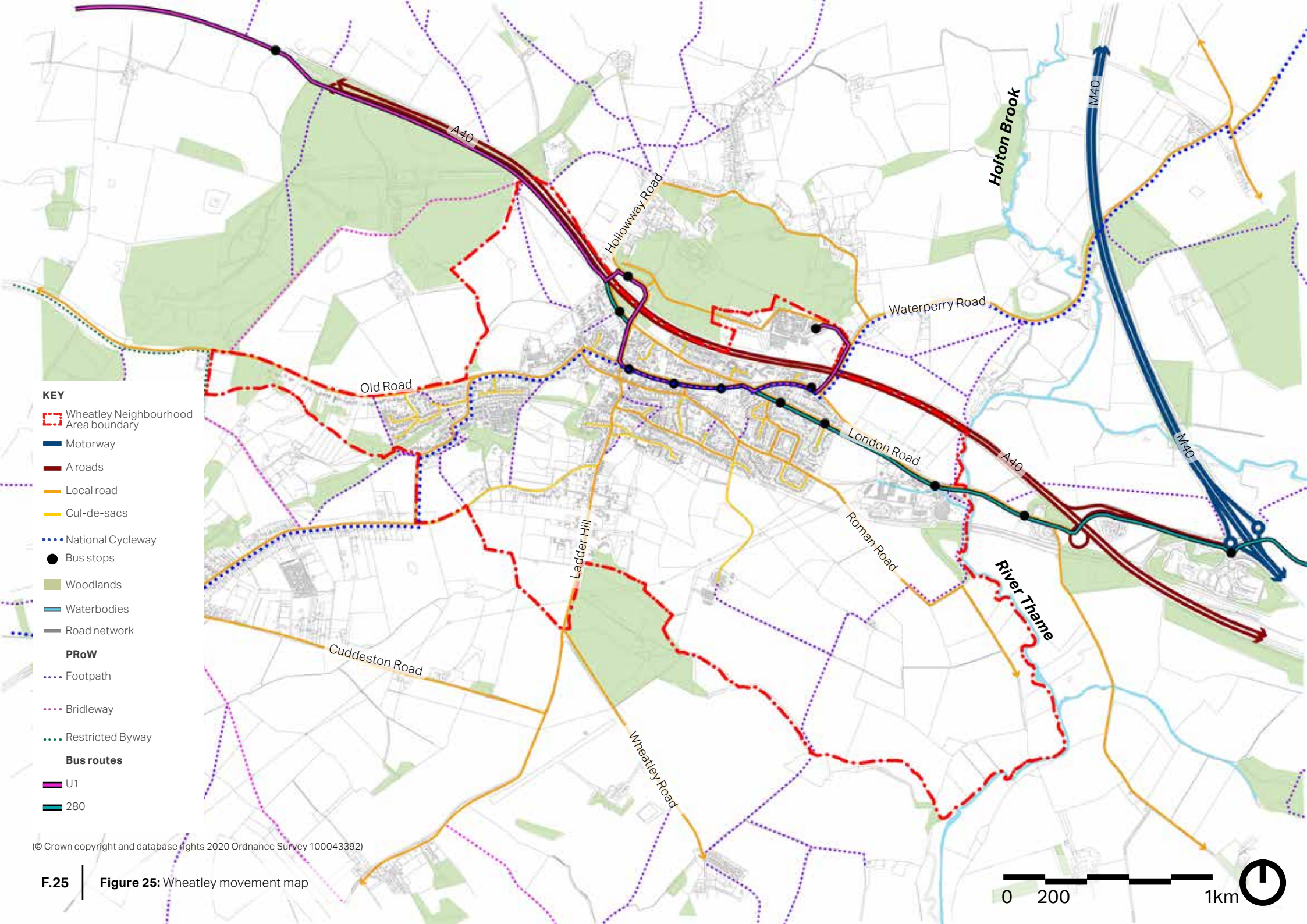

© Crown copyright and database rights 2020 Ordnance Survey 100043392

**F.25** | **Figure 25:** Wheatley movement map



### 3.7 Landscape setting and green space

The South Oxfordshire Design Guide (SODG) identifies Wheatley to be located within the 'Oxford Heights' character area within the wider district. The SODG describes the broad characteristics of the landform and the landscape within the Oxford Heights area as follows: "The area forms a belt of low limestone hills and ridges that surround Oxford and separates the low-lying clay vales which lie to the north and the south" and the settlement patterns as: "Villages are generally found on hilltops and ridges, some of which have spread into nearby valleys. A network of narrow, winding lanes connect the villages with each other."(page 20)

The SODG goes on to describe the broad characteristics of the landscape within the Oxford Heights area as follows: "The area forms a belt of low limestone hills and ridges that surround Oxford and separates the low-lying clay vales which lie to the north and the south." (page 20)



F.26

**Figure 26:** View toward Green belt from Character Area 4



F.27

**Figure 27:** An allotment on Windmill Lane



The landscape surrounding the village of Wheatley is largely open farmland with hedgerow and tree bound fields, parkland and densely woodland. There are two 17th century parks adjoining the village; Shotover Park, once part of the Royal Forest, lies to the northwest and Holton Park to the north. The ancient woodland of Coombe Wood (a 'Park' in 1362), to the south, was given out of Shotover Forest by Henry I to Abingdon Abbey as a Warren.

In terms of topography, Wheatley is situated on a valley floor which runs eastwards towards the River Thame, a tributary of the River Thames, sitting at around 85m. The topography rises steeply towards the south, reaching a plateau of 130m to the south of Coombe Wood.

Within the village, there are range of open spaces which contribute towards its spacious, green setting, such as the Allotments, the common land and the areas of woodland surrounding the village. In addition, the village benefits a wooded character, with many street trees and trees in gardens, which creates an intimate, rural setting.

There are a number of recreation areas within the Neighbourhood Area such as Oxford Brookes & Sports Facilities, Howe Trust Land, Primary School Sports Field, Church Road Recreation Ground, Memorial Ground High Street, Cullum Road Recreation Ground and Farm Close Road Recreation Ground.

The Neighbourhood Plan identifies a number of important views looking out of the village. To the south there is Castle Hill and the poplar ridge of "Cuddesdon on the hill", to the east is the Chiltern ridge and to the north the village of Brill is easily recognised.

**Figure 28:** View towards a drainage ditch running from sewage works to River Thame in the Industrial Character Area next to Asda Petrol Station

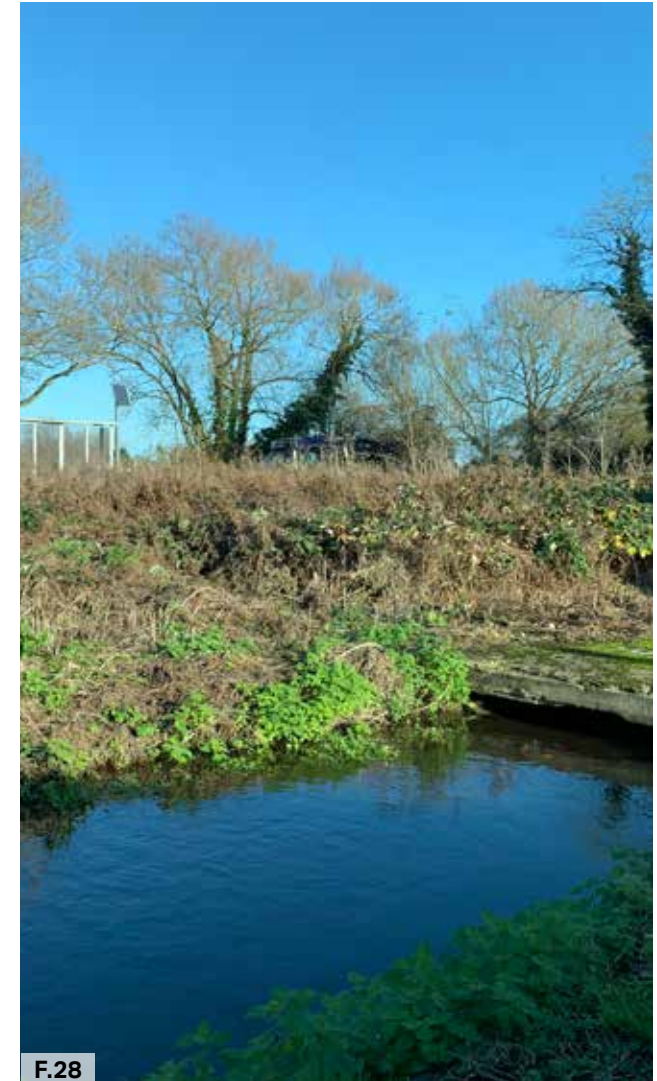

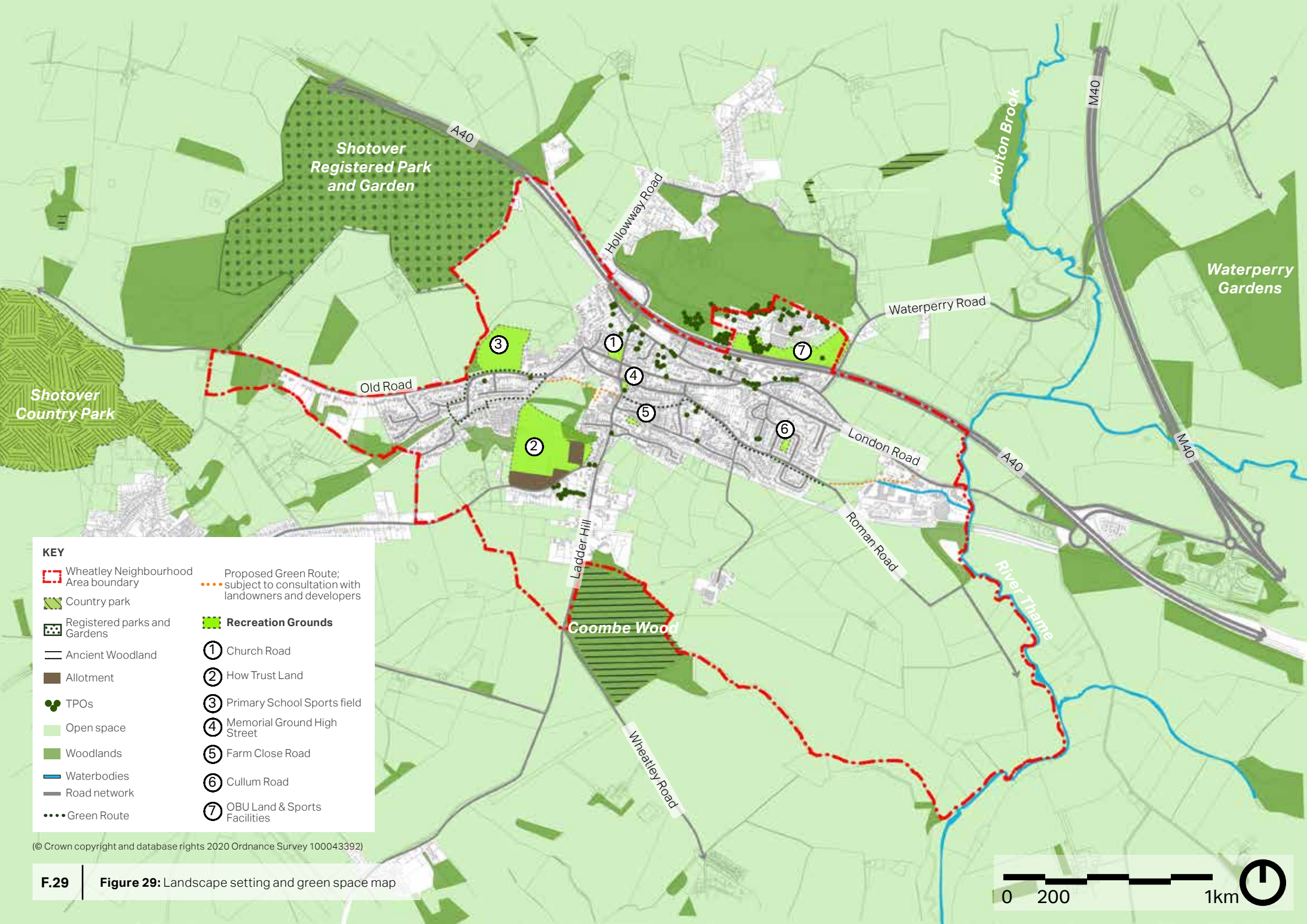

**KEY**

Wheatley Neighbourhood Area boundary	Proposed Green Route; subject to consultation with landowners and developers
Country park	<b>Recreation Grounds</b>
Registered parks and Gardens	① Church Road
Ancient Woodland	② How Trust Land
Allotment	③ Primary School Sports field
TPOs	④ Memorial Ground High Street
Open space	⑤ Farm Close Road
Woodlands	⑥ Cullum Road
Waterbodies	⑦ OBU Land & Sports Facilities
Road network	
Green Route	

© Crown copyright and database rights 2020 Ordnance Survey 100043392

**F.29** | **Figure 29:** Landscape setting and green space map

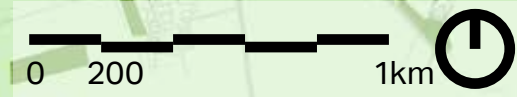

### 3.8 Setting and figure ground

Villages in the Oxford Heights character area, as defined in the SODG are generally found on hilltops and ridges, some of which have spread into nearby valleys. A network of narrow, winding lanes connect the villages with each other.

The village of Wheatley is nestled along a valley floor, formed by a geological fault that eventually levels out towards the east.

The morphology of the village is fairly tightly knit, particularly within the Conservation Area, along the High Street and Church Road. Away from this area, the development pattern loosens slightly, with the post war housing areas such as The Avenue having larger rear gardens. The historic housing fronting Church Road and Crown Road in particular have extremely generous rear gardens.

Littleworth has a consistent development pattern, with medium sized housing and gardens, other than a small cluster of housing around the Cricketers pub.

03  
—



F.30

**Figure 30:** Medium sized housing in Littleworth Character Area



F.31

**Figure 31:** Tightly knit morphology in Character Area 1



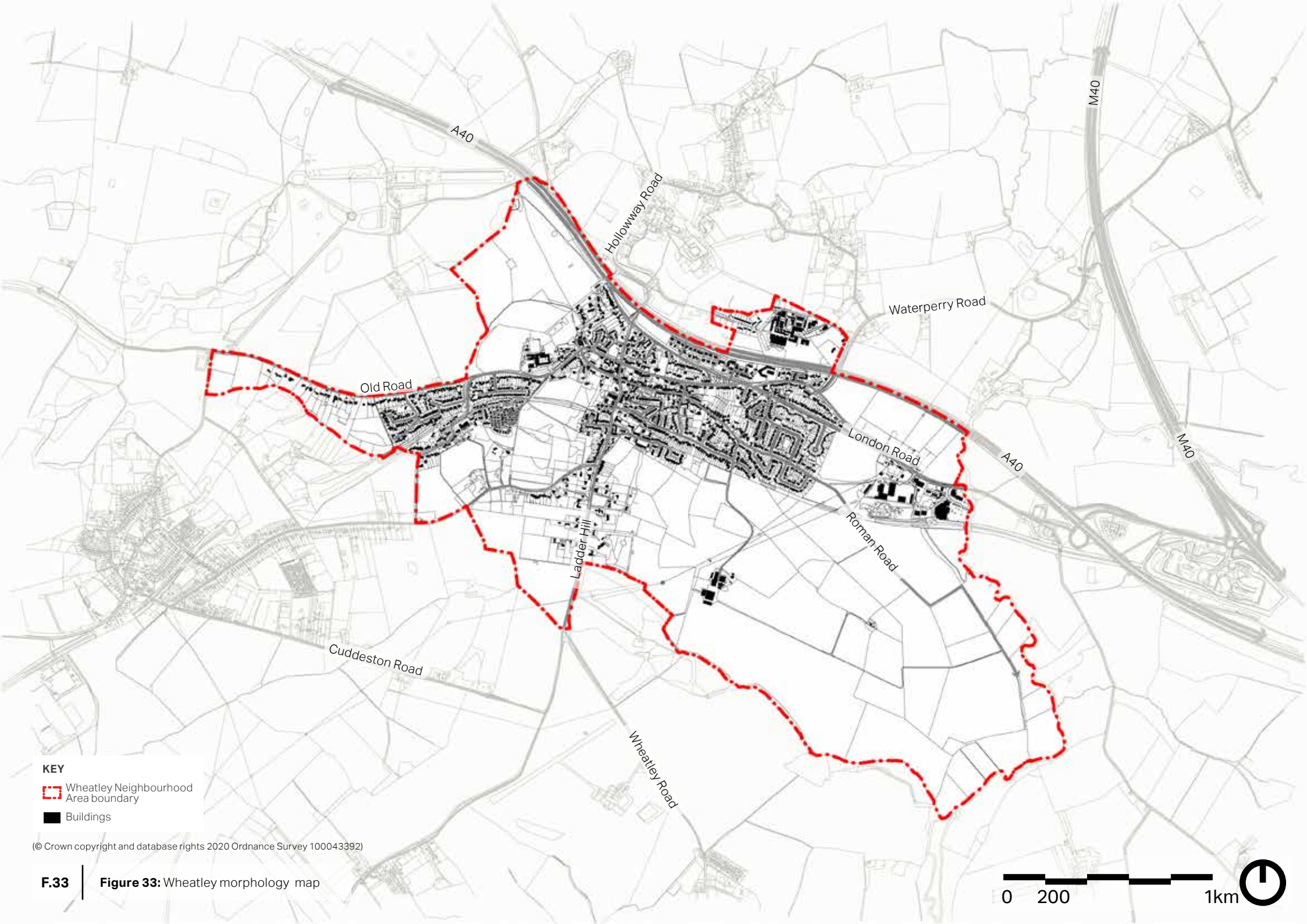

F.32

**Figure 32:** Large grain can be seen on flats building footprint on Beech Road Character Area



**KEY**

-  Wheatley Neighbourhood Area boundary
-  Buildings

© Crown copyright and database rights 2020 Ordnance Survey 100043392

**F.33** | **Figure 33:** Wheatley morphology map



## 3.9 Townscape

### BUILT FORM TYPOLOGIES

The predominant dwelling type in the centre of the village of Wheatley is small cottages and terraces in brick and stone. Roofs are generally traditionally pitched and welsh slate, which was introduced in the 19th century, with the advent of the railway. Outside of the village, generous sized detached and semi-detached dwellings are more commonplace.

### ARCHITECTURAL CHARACTER

There is a consistent, strong character defined by the buildings in the Conservation Area, as a result of a material palette where natural tones predominate. Appendix 1 of the Neighbourhood Plan describes this as: "a harmoniously balanced mixture of local limestone and locally produced warm red brick and tile."

### FENESTRATION

Follows a classic and symmetrical pattern, with a wide variety of individual treatments within that consistent theme.

### ROOFS

There are a mix of roof types, with hipped and pitched being commonplace. Some have dormers. Tile materials are clay or slate.

### PLOT BOUNDARIES

High stone walls and hedges.

### KEY BUILDINGS

There are a number of key buildings in the village, many of which are listed, as follows:

- The manor house, 1601
- St Mary's Church
- Rectory House
- Parish church of St Mary's the Virgin C18th
- United Reformed Church
- King's Arms in Church Road, 1756
- Village lock up, 1834
- Wheatley Windmill, C18th

*"All new development should be designed to preserve or enhance the special character of Wheatley village, as described in paragraph 3.1, to prevent any further erosion of this character and to reinforce the identity of Wheatley as a place. This can be achieved by making appropriate choices for materials, mixing dwelling heights and configurations and using appropriate roof pitches, without being prescriptive about the style of dwellings<sup>1</sup>."*

---

1. [Wheatley Character submission, paragraph 3.5](#)

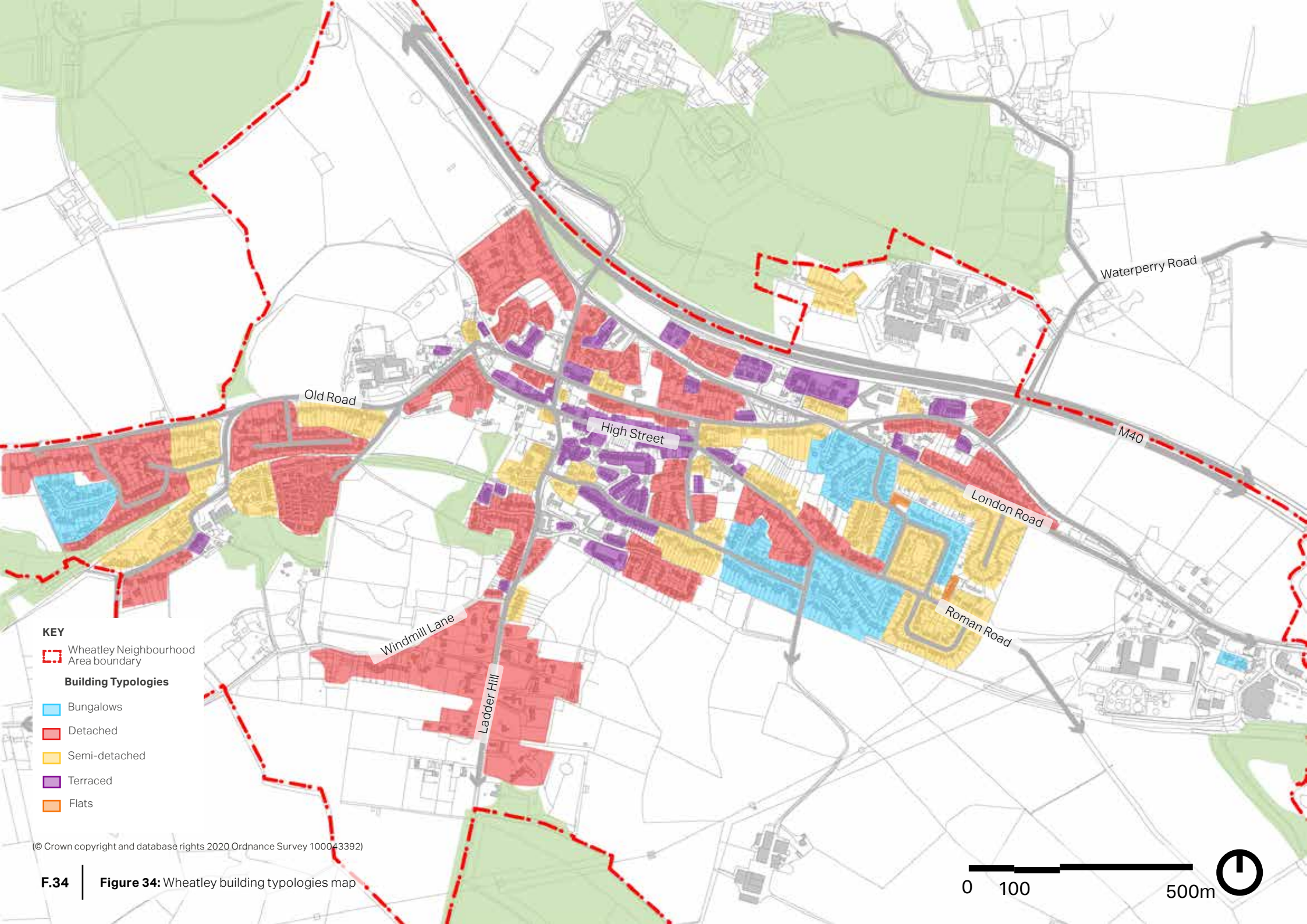

- KEY**
- - - Wheatley Neighbourhood Area boundary
  - Building Typologies**
  - Bungalows
  - Detached
  - Semi-detached
  - Terraced
  - Flats

© Crown copyright and database rights 2020 Ordnance Survey 100043392

**F.34** | **Figure 34:** Wheatley building typologies map





F.35

Figure 35: Buildings providing tight enclosure along the High Street

Village character  
assessment

04





## 4. Village character assessment

### 4.1 Defining the character areas

Following on from the analysis set out above, this part of the report focuses on the different character areas within the village. The different areas are characterised by variations in topography, movement, views and landmarks, green space and landscape cover, public realm and streetscape, built form and architectural details.

The village of Wheatley as it stands today has nine character areas (See Figure 36), which have been defined with the Parish Council, and are as follows:

- CA1- Conservation Area
- CA2- North Wheatley
- CA3- Littleworth
- CA4- Ladder Hill
- CA5- Beech Road
- CA6- Ambrose Rise
- CA7- The Avenue
- CA8- Industrial Estate
- CA9- Oxford Brookes University

**1**  
— **CA1- Conservation Area**

**2**  
— **CA2- North Wheatley**

**3**  
— **CA3- Littleworth**

**4**  
— **CA4- Ladder Hill**

**5**  
— **CA5- Beech Road**

**6**  
— **CA6- Ambrose Rise**

**7**  
— **CA7- The Avenue**

**8**  
— **CA8- Industrial Estate**

**9**  
— **CA9- Oxford Brookes University**

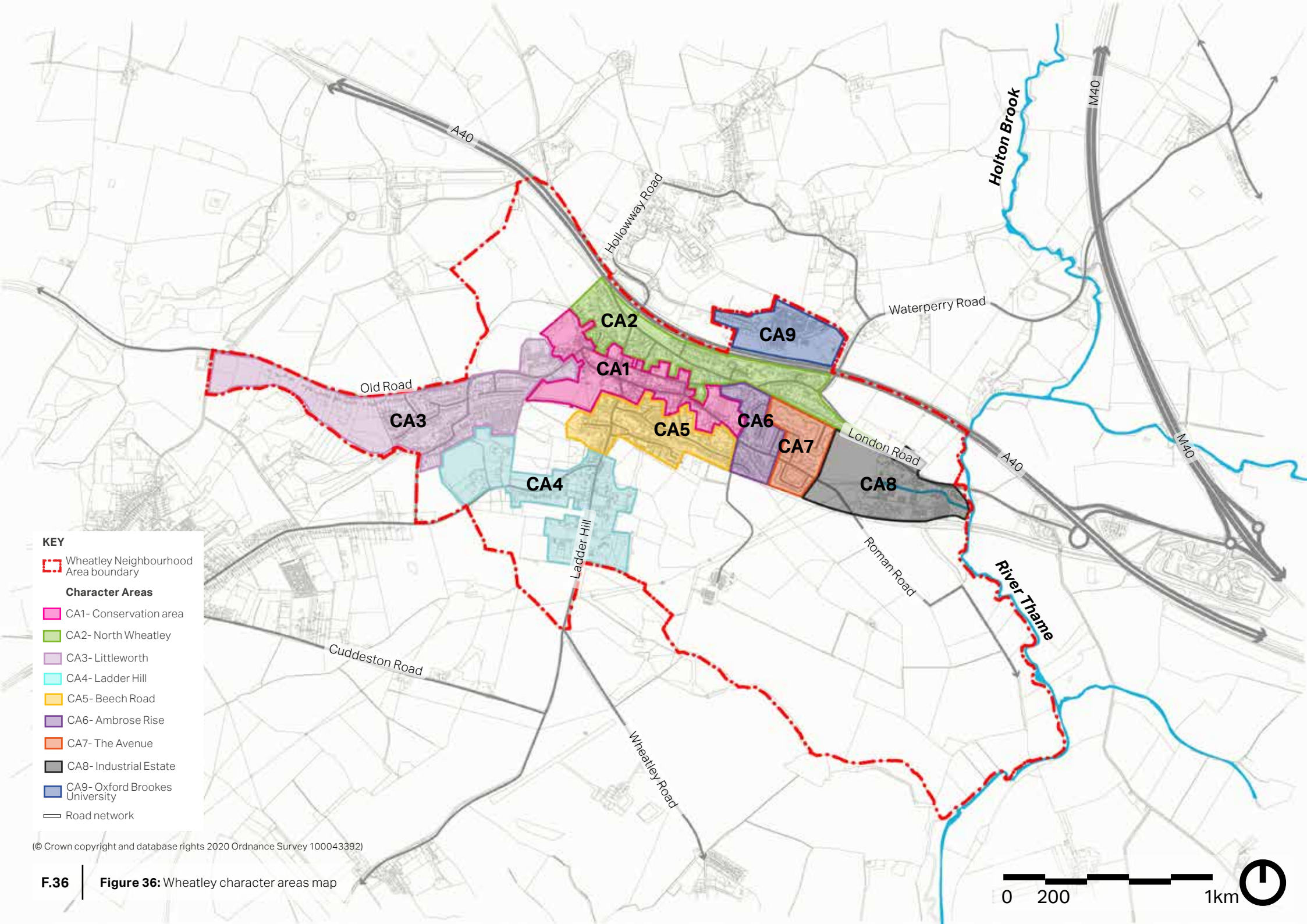

- KEY**
- Wheatley Neighbourhood Area boundary
  - Character Areas**
  - CA1- Conservation area
  - CA2- North Wheatley
  - CA3- Littleworth
  - CA4- Ladder Hill
  - CA5- Beech Road
  - CA6- Ambrose Rise
  - CA7- The Avenue
  - CA8- Industrial Estate
  - CA9- Oxford Brookes University
  - Road network

© Crown copyright and database rights 2020 Ordnance Survey 100043392

**F.36** | **Figure 36:** Wheatley character areas map



# 1 CA1- Conservation Area

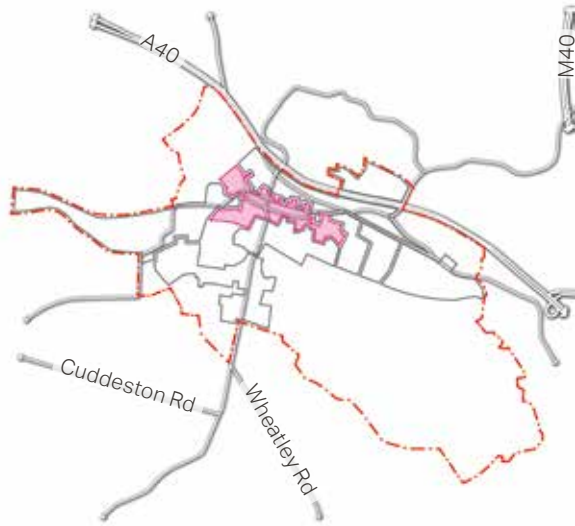

04

Wheatley Conservation Area, established in 1989, forms the core of the village. Two main roads; High Street and Church Road linking this area to other parts of the village.

The main building typologies are terraced with some detached and semi-detached houses. The properties have generally small front and back gardens compared to other character areas with the exception of the properties between Crown Road and Church Road, which have spacious front and back gardens.

<b>Land Use</b>	While the village is largely residential, there are religious and retail uses in Wheatley Conservation Area including Church of St Mary's, shops, Village Hall, Parish Office, Post Office, Wheatley Library, pubs and restaurants. These continue to thrive and this is something that the community are looking to protect.
<b>Pattern Of Development</b>	Linear, with the Conservation Area extending along the High Street and Church Road.
<b>Building Line/Plot Arrangement</b>	Plots are arranged back-to-back in order to maximise natural surveillance, with varied setbacks. The village grain is compact in this character area due to the small front and back gardens. However, bigger plots are found along Crown Road and Church Road.
<b>Boundary Treatment</b>	There is a mix of boundary treatments along Church Road including low walls, wooden fences and hedges and, in some cases, no boundary at all between the building and the public realm. In contrast, the majority of buildings have no boundary treatment along the High Street.
<b>Heights &amp; Roofline</b>	Throughout most of the Conservation Area, buildings are 2 storeys in height. The predominant roof styles are hipped and pitched.
<b>Public Realm</b>	<p>Parking and traffic flow are issues on the High Street. The public realm on Church Road is poorly designed with narrow footpaths which reduces pedestrian safety.</p> <p>A footpath located to the south of the Character Area runs east-west providing safe access to Wheatley Primary Academy.</p>



**Figure 37:** Wheatley Post Office known as 'The Old Bank' on the High Street



**Figure 38:** A mix of terraced and detached houses along the High Street with narrow footpaths on either sides

**Figure 39:** View to Church of St Mary's from Merry Bells car parking area

**Figure 40:** A mix of low wall and flowers as boundary treatment

**Figure 41:** Lock-up as a landmark and Wheatley Play Area on Church Road



**F.38**



**F.40**



**F.41**

# 2 CA2- North Wheatley



04

North Wheatley Character Area is to the north boundary of Neighbourhood Area, just to the south of A40. The main road networks are Park Hill and London Road.

Detached houses are the main building typologies. In addition, some bungalows, semi-detached and terraced houses can be seen. The properties tend to have spacious front and back gardens.

<p><b>Land Use</b></p>	<p>Along London Road development is predominantly residential with some retail, educational and health services, such as the Kings Arms, which is a Grade II listed building, Morland House Surgery, Oxford’s British Orchard Nursery and an aquarium.</p>
<p><b>Pattern Of Development</b></p>	<p>A number of residential estates have been delivered to either side of the primary road network (London Road). Several cul-de-sacs lead off London Road. 20th-century developments were built to the north of London Road on Ochre Close and Breame Oak Drive, with most of the properties being detached.</p>
<p><b>Building Line/Plot Arrangement</b></p>	<p>The majority of building typologies are detached houses. The plots are given generous front gardens and in a lot of cases the buildings have a large setback from the road. This allows for space for private parking, limiting the number of cars parked on the road.</p>
<p><b>Boundary Treatment</b></p>	<p>This area is separated from the A40 by a tree belt. Hedges and low walls create a soft barrier between buildings and the public realm. This helps the area retain active edges at the same time as providing property owners with the reassurance that passers-by are not looking directly into the property. In some case, the presence of mature hedgerows and trees along London Road add interest to this character area.</p>
<p><b>Heights &amp; Roofline</b></p>	<p>Whilst there are different styles of buildings depending on the period they are built in, heights are limited to 1 storey and 2 storeys. Roofs are mostly pitched, and the roofing material is tiles.</p>
<p><b>Public Realm</b></p>	<p>London Road suffers from inappropriate use of roads and verges along with some awkward road junctions which reduce pedestrian safety. There are quite narrow footpaths on Park Hill and London Road which limits walkability. Green verges along some of the roads separate the footpath from the roads. There are some footpaths linking this character area to the countryside and other parts of the village.</p>



**Figure 42:** Two storey building, a converted school house, with pitched roof and tiles as roof material

**Figure 43:** The footpath linking Wheatley Conservation Area to London Road via St Mary's Close

**Figure 44:** New 2-storey development along Breame Oak Drive built with stone and separated from A40 with wooden fences

**Figure 45:** Detached houses along London Road. Green verges along the road with narrow footpath

**Figure 46:** Low wall built with stone - the original boundary wall of Holton Estate - as boundary treatment along London Road



# 3 CA3- Littleworth



04

Littleworth Character Area is located to the west of the NP boundary. Littleworth Road runs along the northern periphery of the CA which merges to become Old Road heading west. Littleworth Road continues through the heart of the CA with residential streets and cul-de-sacs, such as Littleworth Park, Coopers Close/Beeching Way and Keydale Road, branching out from it.

Semi-detached and detached houses are the most common housing typologies in Littleworth, followed by some bungalows. Most houses have ample front and back garden spaces.

<p><b>Land Use</b></p>	<p>The dominant land use in Littleworth is residential, it is also interspersed with some light construction industries and warehouses for vehicle repair to the south. There are 2 primary schools and nurseries located in the eastern part of the CA. A pub - The Cricketers Arms can also be found in this CA.</p>
<p><b>Pattern Of Development</b></p>	<p>Housing is concentrated on either side of Littleworth Road, where houses are arranged along smaller residential streets and cul-de-sacs. Most of the housing stock in this CA is relatively new compared to other parts of the parish and were built in late 1980s and early 1990s - such as those along Copper's Close, Beeching Way, Little Parks Road and Acremead Road.</p>
<p><b>Building Line/Plot Arrangement</b></p>	<p>The dominant housing typologies in this CA are detached and semi-detached where most are predominantly set back from the road with front gardens and off road parking. Car parking is accommodated at the front of most houses, although some households with smaller or no front gardens park on the street.</p>
<p><b>Boundary Treatment</b></p>	<p>This CA is bound by open fields to the north and south, acting as natural edge to the CA and providing a gentle transition to the countryside beyond. Boundaries between houses and roads are often buffered by hedgerows, trees and green verges, helping to soften these barriers, whilst providing visual interest and privacy for houses located along busier roads - such as Littleworth Road.</p>
<p><b>Heights &amp; Roofline</b></p>	<p>Most of the housing stock in Littleworth is 2-3 storeys in height, with several single level bungalows. Pitched roofs are commonly found across the CA, along with hipped roofs. Common roofing materials include red clay pantiles, and slates. The asymmetrical pitched rooflines of houses along Barlow Close are unique to this CA and could be a useful style reference for future developments.</p>
<p><b>Public Realm</b></p>	<p>Pavements, footpaths and the public realm along Littleworth Road are dominated by on street car parking. Parking and traffic on Littleworth Park Lane are key issues to be addressed.</p>



**Figure 47:** Typical detached house with black slate pitched roof and red brick facade, including garage and front lawn, low stone and brick wall boundary treatment - softened by planting

**Figure 48:** Light industrial warehouses located in the southern part of the character area

**Figure 49:** Detached house with tiled hipped roof and dormer windows with white and beige stone facade, along with gravel front lawn and a low stone wall serving as boundary with the road

**Figure 50:** Wheatley CofE Primary School, located in the eastern part of the character area

**Figure 51:** Cricketeer's Arms - local pub and key landmark in the character area, building has a tiled pitched roof and stone facade



04



# 4 CA4- Ladder Hill

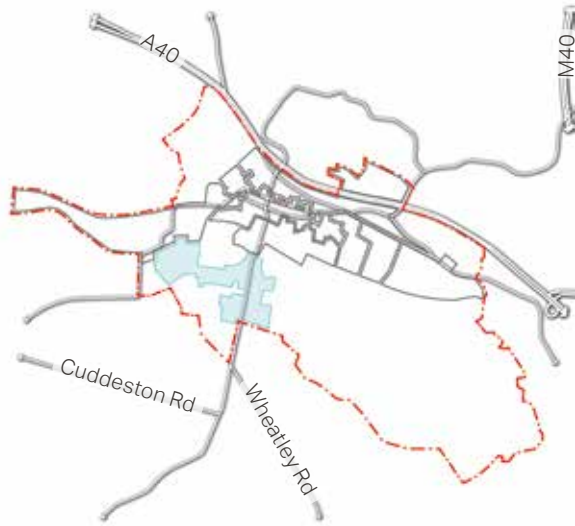

04

The Ladder Hill Character Area is located in the south western part of the NP boundary, the arterial route Ladder Hill runs through the centre of the CA, which has a steep topography. Residential streets branch out from this main route. Typical housing typologies in this CA include detached, semi-detached and terraced houses. Houses are positioned on large plots, providing most with generous front and back garden space.

Several allotments alongside Wheatley Windmill (Grad II listed structure) can also be found in this CA - adding to its character.

<b>Land Use</b>	The predominant land use in Ladder Hill is residential, with a garden centre to the south of the character area on Ladder Hill. Wheatley Windmill, a Grade II listed structure, is located on Windmill Lane, which acts as a key landmark for the parish.
<b>Pattern Of Development</b>	Housing is located along the two arterial routes of the character area - Ladder Hill and Windmill Lane. Most of the housing stock in this CA was built from the 1980s onwards.
<b>Building Line/Plot Arrangement</b>	Predominantly, houses in Ladder Hill are positioned on large plots, providing them with generously sized front and back gardens. Layout is organic and disperses and building lines generally follows this character, which is staggered and informal.
<b>Boundary Treatment</b>	Boundary treatments in the form of hedgerows, foliage and stone walls are commonly used to provide buffering from the main road, which adds to the visual interest of the CA whilst allowing houses to blend in sympathetically with the surrounding rural landscape. Most houses are setback from the road, with some exceptions along narrower stretches of Windmill Lane.
<b>Heights &amp; Roofline</b>	Houses in Ladder Hill mostly range from 2-3 storeys, there are also a handful of bungalow interspersed throughout the CA. Commonly seen rooflines include pitched roofs and hipped roofs with tiles, many of these are seen with dormer windows and chimneys.
<b>Public Realm</b>	Allotment gardens are located on open fields along Windmill Lane, which serves as an important green infrastructure for Ladder Hill. The allotment gardens overlook onto impressive views of the Wheatley countryside. There are also footpaths that link the CA onto nearby fields. Footpaths are narrow along Ladder Hill and are not provided along stretches of it, which could negatively impact on pedestrian safety.



**Figure 52:** 2-storeys detached house with ample front garden space, sensibly set back from the Windmill Road

**Figure 53:** Positive example of the effective use of foliage and architectural materials that is sympathetic towards Wheatley's rural character

**Figure 54:** 2-storey house with tiled pitched roof and dormer window, with a white facade, screened by hedges and trees

**Figure 55:** Allotment gardens along Windmill Lane, overlooking a view of the picturesque Wheatley countryside

**Figure 56:** Wheatley Windmill (Grade II listed) - a landmark that contributes to the character of the parish



# 5 CA5- Beech Road

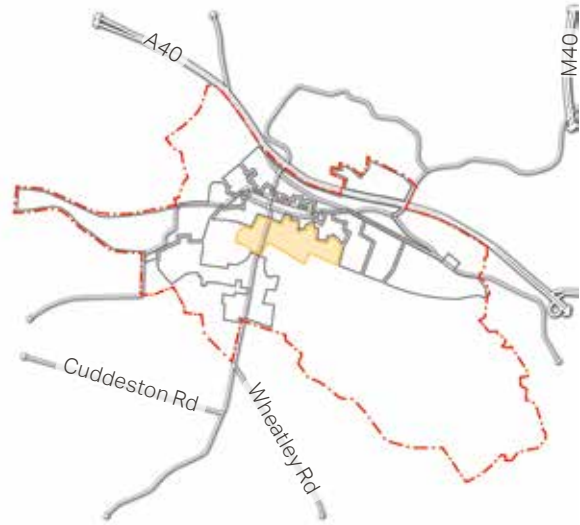

04

The Beech Road Character Area is located within the heart of the NP Boundary, just south of the conservation area (CA1). Primary routes that run through this CA include Beech Road running east-west and Station Road running north-south along the CA's eastern edge. Housing is located along these routes and cul-de-sacs that branch out off these main routes.

Common housing typologies here include semi-detached, terraces and bungalows. Houses are generally built with front and back gardens that vary in sizes depending on the building plots they are positioned on.

<b>Land Use</b>	The dominating land use in Beech Road is residential, with some retail that is located along Station Road - e.g. Co-op supermarket. Additionally, there is a Grade II listed building at 5 and 7 Farm Close Lane.
<b>Pattern Of Development</b>	Development in this CA is mostly concentrated along Beech Road, as well as the smaller lanes, drives and cul-de-sacs that branch out from it - such as Farm Close Lane, Mulberry Drive and Kelham Hall Drive, which connects to Station Road. Houses were mostly built between the 60s and 70s.
<b>Building Line/Plot Arrangement</b>	Sizes of building plots vary in the Beech Road CA with larger plots concentrated along Farm House Close, but most houses have decent sized front and back gardens with parking either at the front of houses or on-street. Most houses front the street, with the exception of some which address the street with their end gables, which sometimes creates inactive street frontages.
<b>Boundary Treatment</b>	Low brick or stone walls are commonly seen boundary treatments in the Beech Road CA, some of these are softened by hedgerows and planting. Most houses are set back from the road and pavement, with front gardens and parking on plot providing privacy.
<b>Heights &amp; Roofline</b>	Most houses in the Beech Road CA are of 2-3 storeys high along with some bungalows - mostly concentrated along Beech Road and Orchard Close. Typical rooflines include pitched tile roofs and some hipped roofs, some of these are seen with dormer windows and many with chimneys.
<b>Public Realm</b>	Most streets in this CA have wide, well-maintained pavements to ensure good levels of pedestrian safety. The wide use of hardscaping - such as low brick/stone walls and fencing as boundary treatment can be softened by incorporating more planting and foliage, which can enhance visual interest for the CA. On street parking is common for this CA due to the generous width of streets.



**Figure 57:** 2-storeys semi-detached houses with landscaped front gardens and driveway for parking



**Figure 58:** Positive local example of a large detached house with red brick and timber board facade and pitched roof, buffered by hedges foliage and wooden fence at the boundary with the pavement

**Figure 59:** 3-storeys terraced houses with yellow brick and green verges and parking in front of houses, adequately set back from pavement and road

**Figure 60:** Typical residential street on Jackies Lane in the Beech Road CA, with good quality pavements and wide street that can accommodate on street parking.

**Figure 61:** Single storey bungalows on Beech Road, with mixed facades of red brick and stone to add to the facade variety in the CA, buffered by landscaping and a low brick wall (Courtesy of Wheatley Parish Council)



F.58



F.60



F.61

# 6 CA6- Ambrose Rise

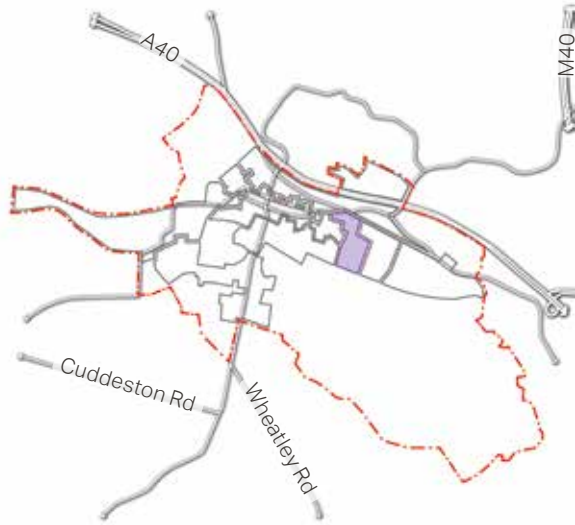

04

The Ambrose Rise Character Area is located in the northern part of the NP boundary, with developments formed along Roman Road, Ambrose Rise and Leyshon Road. Typical housing typologies found in this CA include bungalows and semi-detached houses, with some larger detached houses.

Houses have generous front and back garden spaces, are mostly fronting onto streets and adequately set back to create active frontages.

<b>Land Use</b>	The predominant land use in Ambrose Rise is residential, with a veterinary clinic located on Roman Road. There is also a Grade II listed building (5 Roman Road) in the character area, listed for its architectural details and use of material.
<b>Pattern Of Development</b>	Houses are located along the lengths of Roman Road and Leyshon Road, as well as around the crescent of Ambrose Rise. Houses are mostly semi-detached or detached and are post war. There is a block of flats (Cullum House) on Ambrose Rise which serves as a retirement home.
<b>Building Line/Plot Arrangement</b>	Houses are generally built on larger building plots in this CA, to provide them with ample front and rear garden spaces, with parking spaces accommodated at the front of houses or on street. Cullum House on Ambrose Rise has the largest plot in the character area. Houses generally front onto streets to provide active frontages along these residential streets.
<b>Boundary Treatment</b>	Boundaries between houses and streets are typically buffered by green verges, hedges and low brick walls. Buildings are set back from the street to provide privacy, whilst maintaining passive surveillance for the streets.
<b>Heights &amp; Roofline</b>	Houses range between 2-3 storeys in height alongside bungalows located on Ambrose Rise. Typical rooflines include pitched or hipped tiled roofs with dormer windows and chimneys. Cross-gabled roofs are found on larger houses or extended. There are some more recently constructed houses with flat slate roofs in this character area.
<b>Public Realm</b>	Ambrose Rise is characterised by wide pavements overlooked by houses that are lined with trees, green verges, hedges and low brick/stone walls - adding visual interest for pedestrians. Streets are generally quiet but are rather narrow, meaning excessive on street parking could result in congestion.



**Figure 62:** Typical semi-detached red brick house with generous front and back gardens, set back from the street with a low brick wall at the boundary

**Figure 63:** Bungalow with modern designs - timber board facade and flat slate roof

**Figure 64:** Large bungalow on Ambrose Rise, with red brick facade and hipped roof, with a well-landscaped front lawn with a low stone wall at the boundary

**Figure 65:** Veterinary Clinic on Roman Road

**Figure 66:** Cullum House - a block of 2-stories retirement flats with 12 units on Ambrose Rise

# 7 CA7- The Avenue



04

The Avenue Character Area is located to the south of Wheatley’s arterial route - London Road. It consists of semi-detached housing developed along London Road, and streets that branch out from it. Typical housing typologies include semi-detached and detached bungalows that are concentrated along Roman Road.

The Avenue is also a tree-lined street, providing a pleasant environment for pedestrians. Houses have large front and back gardens, and are appropriately set back from streets.

<b>Land Use</b>	The land use of The Avenue Character Area is residential only. There are no listed buildings in this CA, apart from a Grade II listed milestone located to the east of The Avenue.
<b>Pattern Of Development</b>	The housing stock in this CA has a rich heritage, being characterised by a government subsidised ‘Garden Estate’, comprising fifty tudorbethan style homes, constructed between 1926-28 along what is now London Road and The Avenue. The estate remained on its own, surrounded by green fields and hill landscape, until additional houses were constructed in 1954 (and some latterly, in the 1970s) to the south and west of the Garden Estate. Houses are arranged along London Road, The Avenue cul-de-sac, Elton Crescent, Miller Road, Cullum Road and Roman Road - with most being semi-detached alongside some detached bungalows.
<b>Building Line/Plot Arrangement</b>	Building plots are generally large in this CA, providing houses with large front and back gardens. Many houses have driveways at the front. All houses address the street with their fronts, and are sensibly set back from streets or pavements - creating active frontages for these streets whilst allowing residents to maintain privacy.
<b>Boundary Treatment</b>	Hedgerows, bushes, trees and green verges are commonly used as boundary treatment for houses in this CA and is used the most consistently for houses on The Avenue. Low wooden fences and hedges are used at the boundary between houses and gardens. These boundary treatments help to preserve neighbour amenity and maintain visual interest for pedestrians.
<b>Heights &amp; Roofline</b>	Most houses in the CA are 2-3 storeys in height. Steeply pitched cross-gable roofs with Tudor style detailing are commonly found (mostly along The Avenue) and are unique to this character area. These are often paired with dormer windows and chimneys. Tiled hipped roofs can also be found in this character area.
<b>Public Realm</b>	The Avenue is characterised by tree-lined streets and pavements that are lined by green verges, which adds to its residential character. There is a wide footpath that provides a quieter and car-free alternate route between London Road and The Avenue. There is designated on street parking for some houses on one side of London Road but does not currently impose on traffic along London Road.



F.67



F.69



F.70



F.68

- Figure 67:** Typical semi-detached house with cross-gabled roof and stone and red brick facade on The Avenue
- Figure 68:** Trees lining both sides of The Avenue - enhancing its residential character whilst providing visual interest
- Figure 69:** A shared parking area which forms an inactive frontage to the street
- Figure 70:** A positive example of the use of landscaping, green verges and fencing as boundary treatment, which adds to the overall character of the street
- Figure 71:** Footpath that leads from The Avenue to Roman Road - surveillance by adjacent houses



F.71



# 8 CA8- Industrial Estate

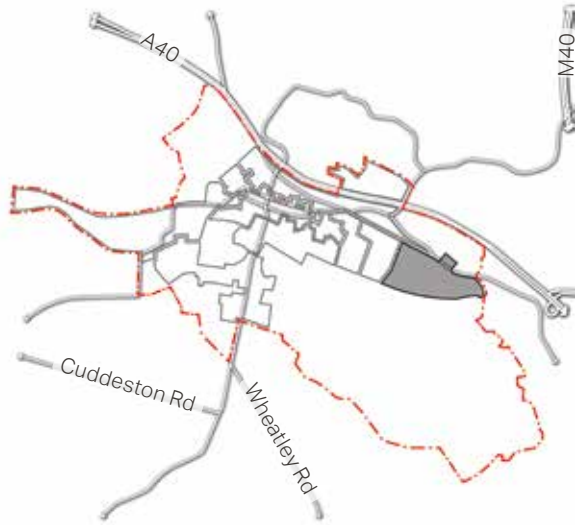

04

The Industrial Estate character area is located within the north eastern part of the NP boundary and extends to the eastern edge of the NP boundary.

It is characterised by large industrial warehouses which are located along London Road - mostly for construction materials manufacturers and other heavy industries.

<b>Land Use</b>	The predominant land use in this CA is industrial, where there are several large warehouses located along London Road. There is also a supermarket (Asda) in the eastern part of the CA, as well as a hotel (Travelodge), Plough and a car dealer (Wheatley Car Centre). There is a small row of houses in between the warehouses and supermarket.
<b>Pattern Of Development</b>	The industrial warehouses are distributed across two areas - a thin strip in between London Road and Old London Road, and further east along London Road where there are several large warehouse with some processing plants. Large carparks are located within the two sites.
<b>Building Line/Plot Arrangement</b>	Buildings largely follow London Road and are sat on large plots. Some 2-3 storeys houses have been converted for light industrial uses or offices for these businesses.
<b>Boundary Treatment</b>	Most warehouses have hedgerows and verges at the boundary and are generously set back from London Road. The small row of houses are also buffered from the main road by a small field, and are set back from the adjacent warehouses. The fields on the western edge of the CA frame the gateway into the settlement, providing an open transition from the natural landscape to the built form. The softer boundary treatments create an appropriate transition between the two land uses.
<b>Heights &amp; Roofline</b>	Due to the industrial nature of buildings in the CA, most buildings are single storey with high ceilings and corrugated roofs. With the exception of some houses which were converted as offices for some of the businesses - these are mostly 2 storeys and have pitched roofs. These are Mobb's offices.
<b>Public Realm</b>	This character area is accessible via London Road, which is a major thoroughfare into and out of Wheatley. A narrow pavement is provided mostly along one side of London Road. Both sides of London Road are lined with hedges and green verges, and have views to nearby open fields - maintaining visual interests for pedestrians and providing a pleasant approach into Wheatley.



**Figure 72:** Views to nearby open fields and Wheatley Farm Shop along London Road



**Figure 73:** Car dealership fronting onto London Road

**Figure 74:** Tree and hedgerow-lined narrow pavement along London Road



**Figure 75:** Houses interspersed with warehouses, set back from both London Road and nearby warehouses



**Figure 76:** Asda supermarket



# 9 CA9- Oxford Brookes University



04

Oxford Brookes University Character Area is located to the north of Neighbourhood Plan Boundary and falls in the Holton Parish. It is situated to the north of the A40 and can be accessed via College Close. The South Oxfordshire Local Plan 2035 allocates the land at Wheatley Campus to deliver 500 new dwellings along with an amendments to the Green Belt boundary.

<b>Land Use</b>	The site comprises the campus and two residential plots with detached houses lying to the east of the site accessed from waterperry Road.
<b>Pattern Of Development</b>	There is a cluster of buildings with educational use at the heart of the CA with some parking areas scattered within the CA. The campus has compromised the feel of openness and the village’s rural character. There are some derelict properties to the west of the area.
<b>Building Line/Plot Arrangement</b>	A mix of apartments with a few one-storey buildings are used for educational use. Most of the buildings follow the road alignment. Few open spaces are designed in the form of courtyards serving the educational buildings.
<b>Boundary Treatment</b>	Garden Copse Woodland is located to the northeast of the character area. The area is surrounded by a row of woodland along A40. The buildings either do not have defined boundary treatment or on some occasions, hedges or low walls are provided.
<b>Heights &amp; Roofline</b>	Oxford Brookes University Tower is the highest building in this character area. Other buildings vary from 1 – 4 storeys, with flat roofs.  The majority of buildings have flat roofs along with some gabled roofs providing subtle changes within the CA silhouette.
<b>Public Realm</b>	The campus is accessed via A40. College Close branches off Waterperry Road and is used by cars and motorists. There is no footpath on either side of College Close. This CA has been extensively landscaped and there are many Tree Preservation Orders (TPOs) within the CA, which provide natural enclosure and shading, as well as visual interest.



F.77



F.79



F.81



F.78



F.80

**Figure 77:** View to educational facilities in Oxford Brookes University and OBU Tower

**Figure 78:** Derelict buildings to the west of the character area

**Figure 79:** View to Holton place, a Grade II listed building

**Figure 80:** The existing car parking in front of university buildings

**Figure 81:** View to Oxford Brookes University, Wheatley campus Business School

## 4.2 Defining the areas for coding

For the purpose of Design Coding the Neighbourhood Area has been divided to the following 4 areas:

### **HISTORIC CHARACTER AREA:**

The historic character in this area strengthens Wheatley's sense of place. Development in this area is sensitive to change and the degradation of its historic character should be avoided.

### **SETTLEMENT EDGE:**

These areas are located mainly around the settlement edges of the village. Development in these areas, at the interface between natural and developed landscapes, should be controlled to avoid the degradation of the surrounding landscape character.

### **INDUSTRIAL ESTATE DEVELOPMENT:**

The industrial area is characterised by a central distribution road and a regular pattern of industrial buildings.

Development within this area is feasible, but must be carefully designed to respond to its edges, so that there is a green buffer between any new housing and the existing industrial edge, and so that it integrates with the existing housing along The Avenue and London Road.

### **RURAL SURROUNDING LANDSCAPE:**

This area comprises of the remaining area outside of the village settlements and comprises of open rural countryside, hedgerow and tree bound farmland and small clusters of housing and farms.

### **POST - WAR/MODERN CHARACTER AREA:**

These areas comprise of the later additions to the villages. These areas largely comprise of cul-de-sac and estate-like development patterns.

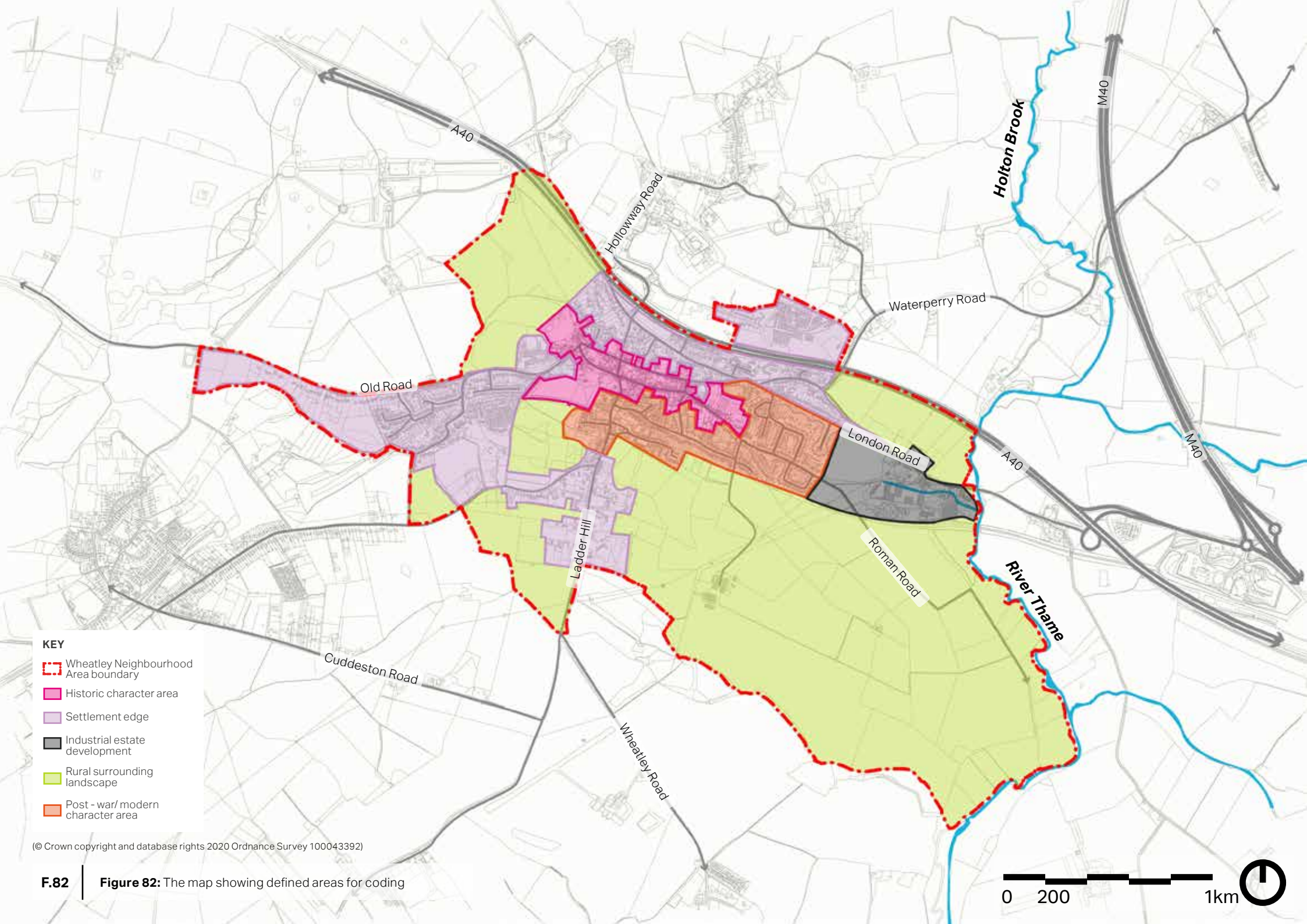

- KEY**
- Wheatley Neighbourhood Area boundary
  - Historic character area
  - Settlement edge
  - Industrial estate development
  - Rural surrounding landscape
  - Post-war/modern character area

© Crown copyright and database rights 2020 Ordnance Survey 100043392

**F.82** | **Figure 82:** The map showing defined areas for coding



**Design guidance  
and codes**

**05**



# 5. Design guidance and codes

## 5.1 Introduction

It is important that any new development in Wheatley responds to, enhances its special sense of place, and meets the aspirations of its residents. With this in mind, this section identifies design guidelines and design codes for future housing developments to adhere to, based on the contextual analysis presented in the previous sections. This design guidelines and codes consider the unique setting and character of the village.

The following design guidelines and codes have been identified and will be explained in more detail in this section of the report:

### GENERAL DESIGN GUIDELINES

1. Wellbeing (WE)
2. Greenspace and landscaping (GL)
3. Settlement layout (SL)
4. Heritage and tradition (HT)
5. Sustainability (S)
6. Visual variety (VV)
7. Movement and connectivity (MC)

### SPECIFIC DESIGN GUIDELINES

1. Block principles
2. Streetscape principles
3. Parking and natural surveillance
4. Plot principles
5. Building principles
6. Industrial estate principles



## 5.2 When to use the codes

The table below identifies when each of the codes should be used. A prefix has been created for each code to allow simple application of the design codes to the coding areas on the following page.

General principles	Prefix	When to use the code
<b>Wellbeing (WE)</b>	WE 01	Code to be applied when there are green spaces, lanes and allotments.
<b>Greenspace and landscaping (GL)</b>	GS 01	Code to be applied when a proposed housing development has potential impact in green space and planting.
	GS 02	Code to be applied in time of designing front gardens.
<b>Settlement layout (SL)</b>	SL 01	Code to be applied when the new settlement will be built on edge of the village.
	SL 02	Code to be applied when the new settlement will be built as a gateway.
	SL 03	Code to be applied when the new settlement will be built as an infill.
<b>Heritage and tradition (HT)</b>	HT 01	Code to be applied when the new settlement will have adverse impact on the conservation area setting.
	HT 02	Code to be applied when the new settlement will have adverse impact on the conservation area character.
<b>Sustainability (S)</b>	SE 01	Code to be applied to all future housing development to introduce Sustainable Drainage systems where applicable.
	SE 02	Code to be applied when the new development to build energy efficient housings.
	SE 03	Code to be applied when the orientation of housings can restrict the solar gain.
	SE 04	Code to be applied when the new settlement will have impact on biodiversity.
<b>Visual variety (VV)</b>	VV 01	Code to be applied when the new settlement can influence th quality of townscape.
	VV 02	Code to be applied when enhancing the streetscape.
	VV 03	Code to be applied when determining the house typologies.
<b>Movement and connectivity (MC)</b>	SM 01	Code to be applied to improve the street connectivity.
	SM 02	Code to be applied when some traffic calming measure needed to solve the traffic problems.

<b>Specific principles</b>	<b>Prefix</b>	<b>When to use the code</b>
<b>Block principles</b>	1A	Code to be applied where a development could impact upon green space and views to the surrounding landscape.
	1B	Code to be applied when building lines are not in keeping with adjacent character area.
<b>Streetscape principles</b>	2A	Code to be applied when determining the heights and scale of future developments.
<b>Parking and natural surveillance</b>	3A	Code to be applied when design can improve the security by improving natural surveillance.
	3B	Code to be applied when designing how parking will be provided within future housing developments.
<b>Plot principles</b>	4A	Code to be applied when the future backland and infill will be designed.
	4B	Code to be applied when extensions will be added to the existing character of the village.
<b>Building principles</b>	5A	Code to be applied to all future housing be designed in keeping with architectural details.
	5B	Code to be applied to any new developments to be built in keeping with building vernacular .
<b>Industrial estate principles</b>	6A	Code to be applied to the layout and building appearance in any potential developments in close proximity to the industrial estate.
	6B	Code to be applied when industrial estate adversely impact on views and connections to the countryside.
	6C	Code to be applied when guide need to design the boundary treatment in industrial area.
	6D	Code to be applied when industrial estate adversely impact on views and connections to the countryside.

# 5.3 How to apply the design guidelines and codes

Each of the areas on the plan (See Figure 83) relates to the appropriate design code prefix from the above tables, to enable an understanding of where each of the codes should be applied in the village.

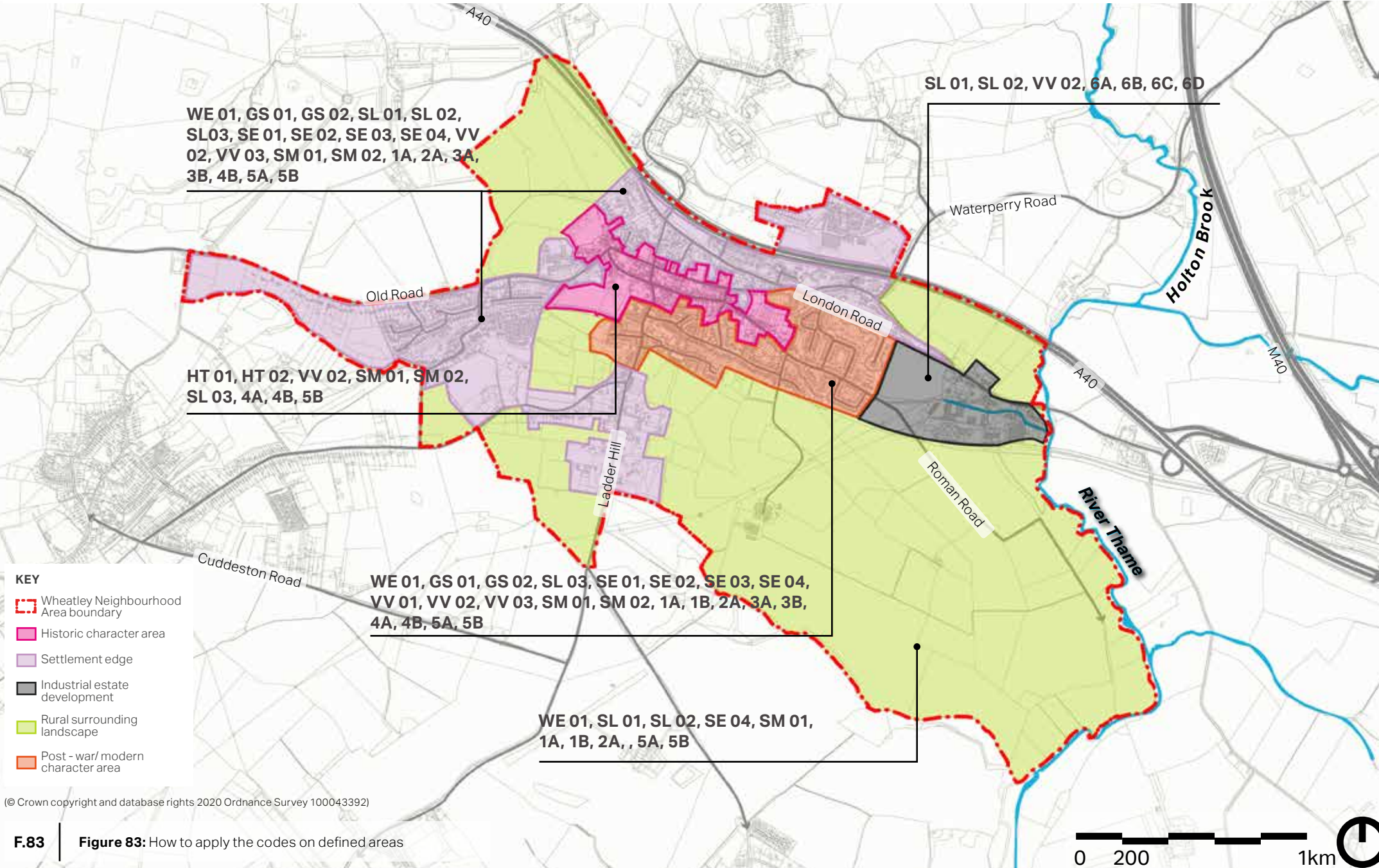

© Crown copyright and database rights 2020 Ordnance Survey 100043392

**F.83** | **Figure 83:** How to apply the codes on defined areas

## 5.4 Design guidelines

The following design guidelines are applicable to all character areas across the Neighbourhood Area and should be applied as a starting point to all new development, regardless of where it is in the Neighbourhood Plan Area. These guidelines promote landscape and character led design which responds to the natural environment and enhances the existing townscape. Reference to context does not mean to copy or replicate in a pastiche manner, it means taking inspiration and influence from surrounding precedent, helping to form a design rationale which harmonises with the surrounding area.

**1**  
— **WE. Wellbeing**

**2**  
— **GL. Greenspace and landscaping**

**3**  
— **SL. Settlement layout**

**4**  
— **HT. Heritage and tradition**

**5**  
— **S. Sustainability**

**6**  
— **VV. Visual variety**

**7**  
— **MC. Movement and connectivity**

# 1 WE. Wellbeing

## WE 01- PEOPLE-FRIENDLY NEIGHBOURHOOD

Wellbeing relates to our physical and mental state. There are a number of factors that can influence our wellbeing. A holistic approach to this is the 20-minute neighbourhood concept, which is defined by the TCPA in their recent guide "Creating Healthier, Active, Prosperous Communities" as a place in which most of people's daily needs can be met within short walk or cycle. The guide defines 20 minutes as the maximum time that people are willing to walk to meet their daily needs

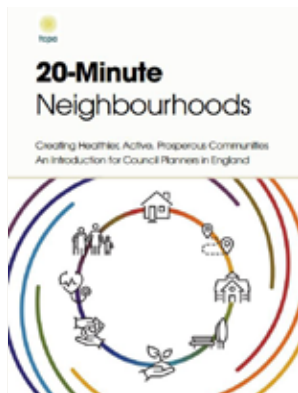

F.85

Figure 85: TCPA 20-minute neighbourhoods

and that the 20 min journey represents an 800m walk from home to a destination and back again (10 minutes each way).

The impact of Covid has made the 20-minute neighbourhood even more pertinent, with access to local facilities and green and natural space being so important for wellbeing. The benefits include:

- People chose to stay in the neighbourhood for longer as they are diverse and cater for a wide range of needs/lifestyles;
- People become more active which improves mental and physical health;
- Traffic is reduced, and air quality improved;
- Local shops facilities benefit from increased patronage;
- People connect with nature;
- People see more of their neighbours, strengthening community bonds; and



F.84

Figure 84: The green space around Wheatley War Memorial

- Neighbourhoods become generally safer for all, but particularly children, due to the points above.

The village of Wheatley is well set up for the 20-minute neighbourhood, given its compact size and good provision of walking routes. There are some additional factors that influence wellbeing, which include:

### **Access to nature and greenspace**

It is now widely acknowledged that access to nature and green space has an extremely therapeutic effect on the mind. The National Model Design Code recognises this in paragraph 57:

“Development should enhance the natural as well as the built environment. Nature is good for health and wellbeing, for biodiversity, shading and cooling, noise mitigation, air quality and mitigating flood risk as well as contributing to tackling the climate emergency. Nature is also central

to the creation of beautiful places.”

Wheatley has many different types of green space, including the allotments on Windmill Lane and also benefits from a green setting with many trees throughout the village, as shown on Figure 28, earlier in this document. It also benefits from having a wide range of natural areas of woodlands and parkland surrounding the village, which provide valuable habitat for wildlife. The National Design Guide recognises the benefits of this in paragraph 82 : “All new development needs to use, retain and improve existing habitats or create new habitats to achieve measurable gains for biodiversity. This includes landscaping and tree planting.” This subject is covered more in Design Guideline GS01.

### **Food production**

Space for food production is also important for wellbeing, as it increases access to a range of food, provides educational opportunities and reconnects residents to their surroundings, and each

other. It also boosts self-esteem, by providing a sense of purpose.

Therefore, new development in the village should:

- Provide access to a wide range of multifunctional, semi natural green open space for the benefit to people and wildlife;
- Provide growing space;
- Prioritise tree planting to maintain the green setting of the village;
- Retain any natural features, such as trees and hedgerows, for the benefit of local wildlife;
- It should provide excellent walking and cycling links, focusing on active travel over and above the car; and
- Provide facilities where residents can socialise and interact.



**F.86**

**Figure 86:** View to allotment to the north on Windmill Lane

## 2 GL. Green space and landscaping

### GS 01 - TREES AND LANDSCAPING

Specific opportunities to integrate street greening, public green space and improve green infrastructure network connectivity should be design drivers for all new development. As set out in paragraph 131 of the NPPF, trees make an important contribution to the character of a place, and can also help mitigate and adapt to climate change. Wheatley benefits from many street trees and areas of woodland surrounding the village, which contributes significantly towards its pleasant, rural character.

The following principles should be considered with new developments:

- Hedgerows are not only a traditional feature of the landscape, but an important habitat forming a green infrastructure network across the county and should be preserved;
- Tree and plant species specification should be appropriate for the

microclimate of the village, should be native and should include management requirements and seasonal colour variation. Ornamental single species planting should be avoided, a diverse planting preference provides improved habitat and better disease resistance;

- Gardens should be planted and designed with nature in mind, incorporating bolt-on products for habitat protection such as bat bricks, bird boxes and hedgehog gravel boards.

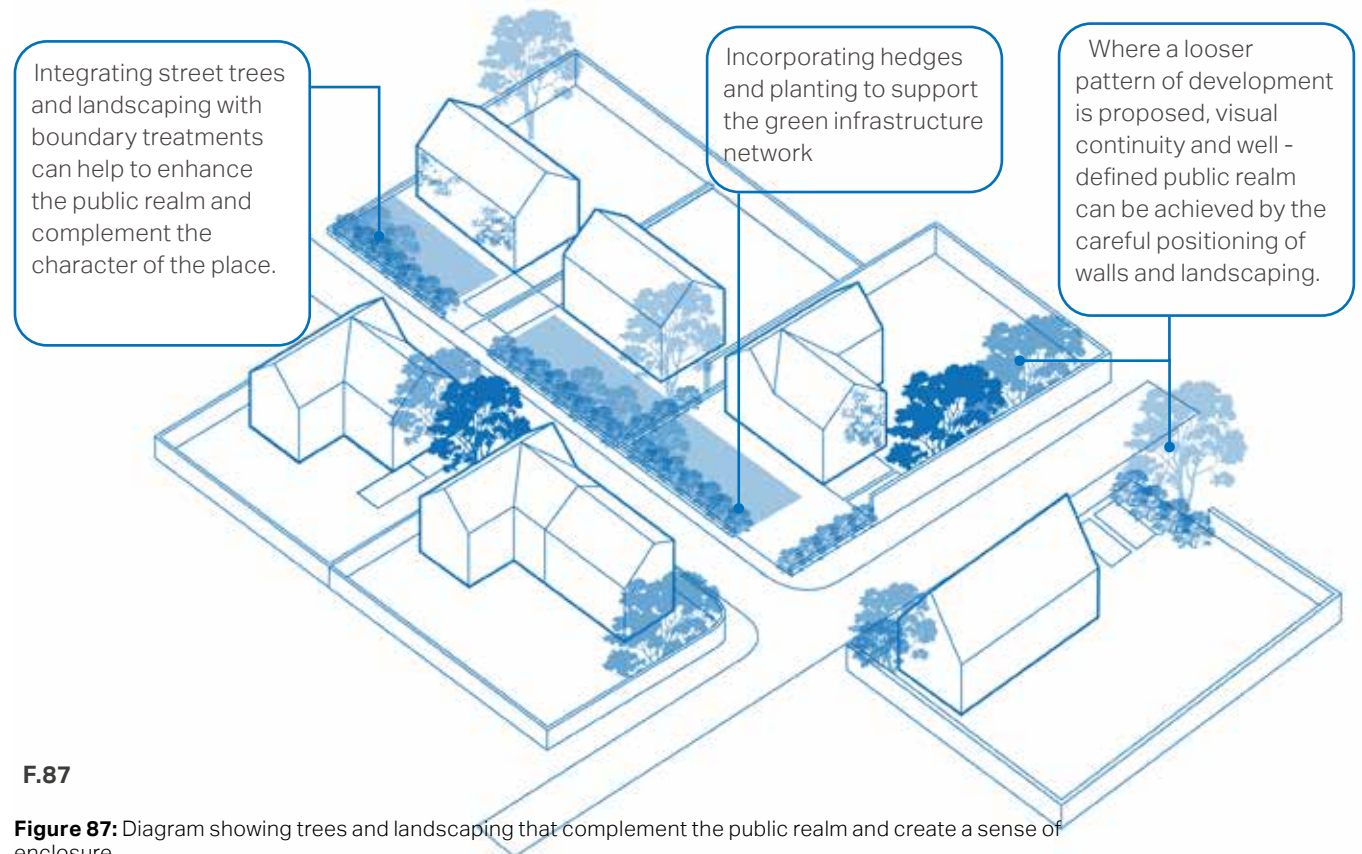

F.87

**Figure 87:** Diagram showing trees and landscaping that complement the public realm and create a sense of enclosure



## GS 02 - GARDENS

- Front gardens or simple frontages, where this is characteristic of the development area should incorporate planting which supports biodiversity;
- Gardens should be considered as ecological corridor extensions and designed to connect with surrounding green infrastructure networks; and
- Bolt-on products can be also used to improve ecological sustainability by improving access or providing habitat. Bat bricks, bird boxes and hedgehog gravel boards are some examples for consideration within new development.



F.88



F.89



F.90

**Figure 88:** Mature trees along a lane lead off Windmill Lane

**Figure 89:** Examples of a bughouse decorating rear gardens or public green

**Figure 90:** Examples of a frog habitat decorating rear gardens or public green spaces.

# 3 SL. Settlement layout

The following principles should be considered with new developments:

- Consider the village as a whole and should not be considered in isolation;
- Integrate well into the existing built form, taking opportunities to connect pedestrian routes and green spaces where possible;
- The village centre should reflect existing higher densities with a tighter grain, whilst the edge of the village should remain low density with a looser grain;
- Edge of settlement development should gradually transition to the surrounding landscape context, with a soft, low density edge. Building elevations along the existing village edge should connect into it and should provide an attractive and positive frontage;
- Promote active travel at all times, connecting into the existing footpath network and discouraging car use;
- Respond to micro-climates and sun paths and use these as key design drivers to increase the environmental comfort.

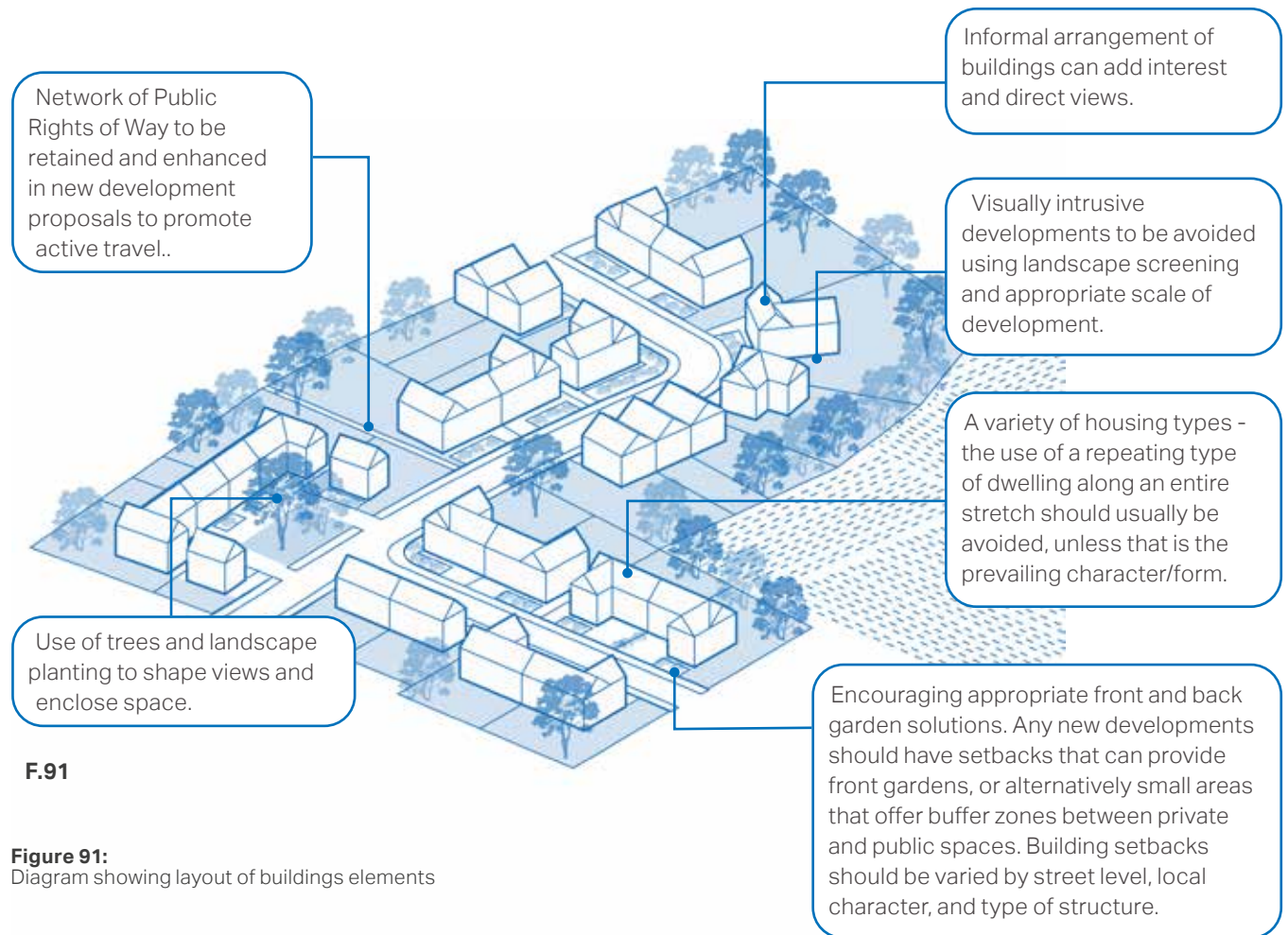

**F.91**

**Figure 91:**  
Diagram showing layout of buildings elements

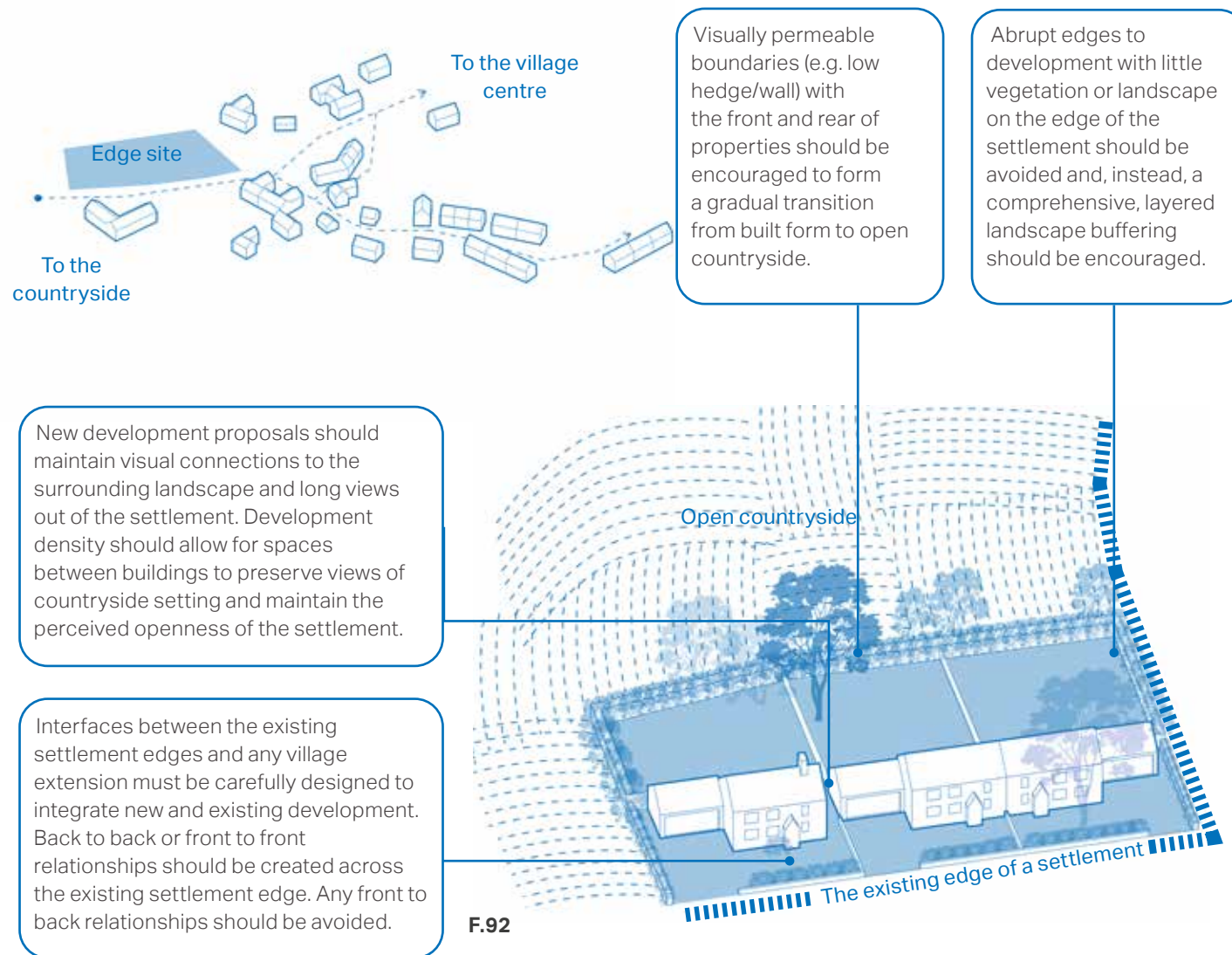

**Figure 92:** An indicative diagram highlighting elements of design codes for an edge site

## SL 02- GATEWAY

- A gateway site is normally situated at the edge of a settlement, near to a main route into the settlement. It marks the transition from one space to another, and is a point of arrival into (and departure from) a settlement, usually from the surrounding landscape setting.
- The sense of departure and arrival can often be achieved by a noticeable change in scale, enclosure, or road configuration. The gateway buildings or features should, however, reflect local character.

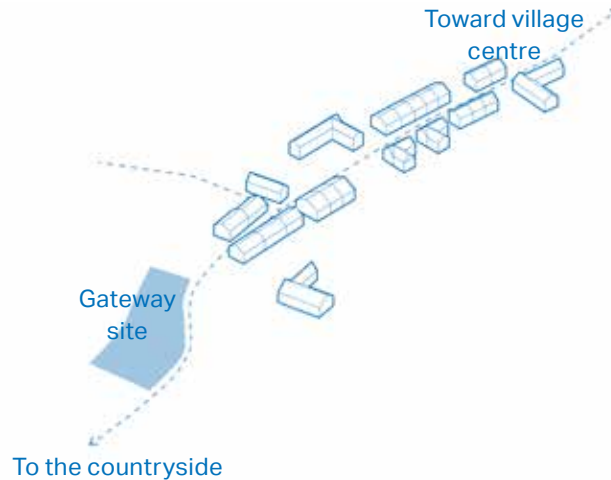

**F.93**

Single building or a small group of buildings located at the corner of a gateway site and along the main route.

If a gateway plot is developed with a number of buildings, the corner of the site should act as the key landmark. The corner building could be slightly taller or display another built element, signalling its importance within the grouping.

Fenestration contributes much to the character of a building. Long stretches of blank (windowless) walls should be avoided, including on side elevations, except where this is in keeping with the character (e.g., farmyard-type buildings).

**Figure 93:**  
An indicative gateway site leading into a linear settlement

**Figure 94:**  
Indicative sketch highlighting elements of design codes for a gateway site

As well as buildings acting as gateways, high quality landscaping features can also be used fulfil the same function, especially tree planting.

A gateway site should respond to existing development / landscape on the opposite side of the main route into the settlement.

In the case of fencing for back gardens or perimeter walls, the quality of the materials is key. Panel fencing should be avoided. Instead, vernacular treatments should be used such as: brick walls, hedges and landscape planting; etc.

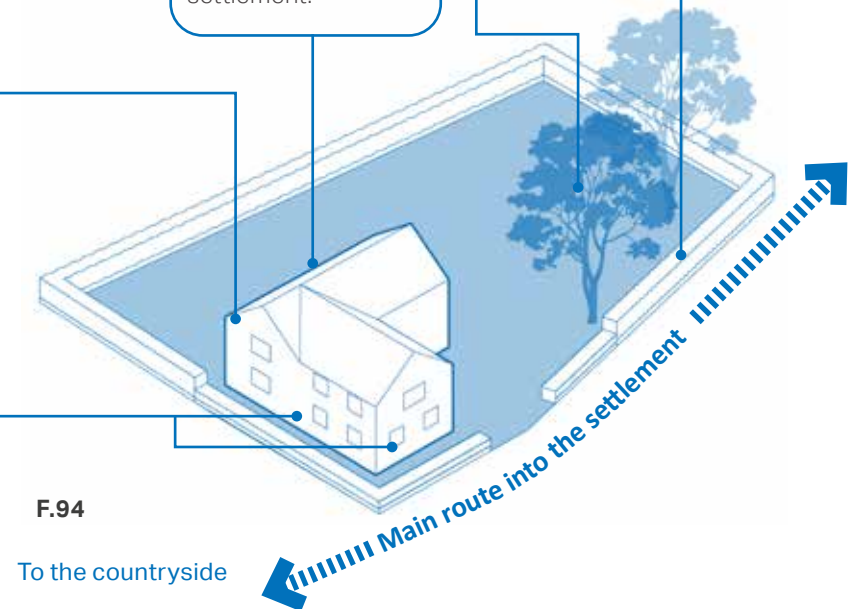

**F.94**

To the countryside

## SL 03- INFILL

Infill sites will vary in scale, context and location within a settlement. Any new infill can have significant impact on the character and appearance of the built environment. The following principles should be applied in any future infill site:

- Infill development should complement the streetscene. It does not need to mimic the existing styles but its scale, massing and layout should reflect the locality within which it sits (this is particularly applicable to ridge/eave heights, especially for terraced or dense groupings of buildings);
- The building line of new development should be in conformity with the existing. Very often, with terraced or dense groupings, the building line will be exactly the same, but in other cases it might be acceptable that it closely aligns with the exiting arrangement of buildings where there is an irregular, meandering building line; and

- The density of any new infill development should reflect the character of the immediate area and location within the village, in accordance with Policy H1: Design and Character Principles of the Neighbourhood Plan and Policy STRAT5: Residential Densities of the Local Plan. The optimum density will respond to surrounding densities, whilst making efficient use of land.

New building lines should be consistent with existing properties. Some places in Wheatley have linear or regular meandering arrangements of buildings while others have random and irregular patterns. The infill should also reflect the surrounding context in terms of form, materials and height/massing.

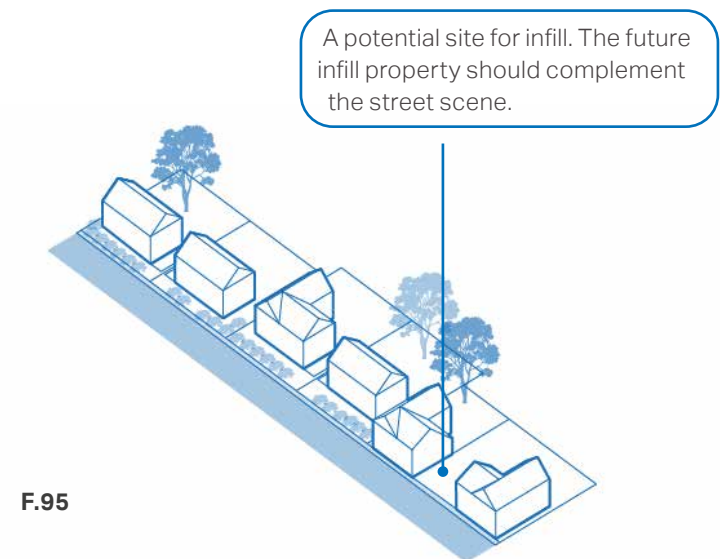

F.95

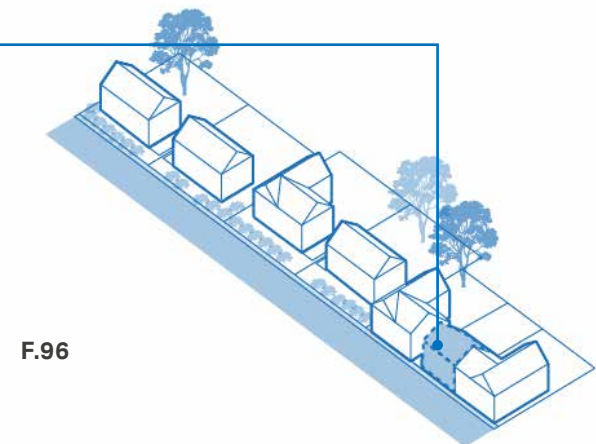

F.96

**Figure 95:**  
An indicative diagram highlighting a site before infill

**Figure 96:**  
An indicative diagram highlighting a site after infill



**Figure 97:**  
A positive example of infill on the High Street

**Figure 98:**  
A view from London Road toward the timbered housing on The Avenue. The corner building with unique character acts as a gateway

**Figure 99:**  
A group of bungalows on London Road on the edge of settlement

# 4 HT. Heritage and tradition

05

The retention and incorporation of existing historic buildings can be a linchpin for new development, giving it more meaning and helping ensure that it is of its place and connected to the past. The approach to heritage must be one of protecting and enhancing historic assets, of which there are many in the village (e.g. listed buildings, Scheduled Ancient Monuments), including both statutory designations and local designations. The village fabric of Wheatley is already interwoven with both traditional and more modern development (post-war), although predominantly retains its traditional character which is most valued by residents. Indeed, the local preference is for building that responds to heritage and traditional context to preserve and enhance the traditional appearance of the village.

The village shows that it can evolve sensitively whilst referencing local traditions such as building form, scale, types, materials and arrangement. More recent developments have integrated less successfully into the village (in external appearance) than other more sensitive development.

New development should respond to the predominant building height, but can include changes in the roofscape (roof pitch and style) to contribute to the visual interest of the village.



**Figure 100:**  
The view to Church of St Mary's should be protected



**Figure 101:**  
Respect the view toward Lock Up from different directions

## HT 01- Respect setting

- The historical relationships between the settlements, St Mary’s Church, the Parish Office, woodlands, mature trees and other community facilities should be clearly defined;
- Enhance the existing views towards St Mary’s Church and the Lock Up along the street;
- Protect the character of the Parish by protecting views to the surrounding countryside and into the Parish; and
- Maximise opportunities for the restoration, enhancement and connection of natural habitats.

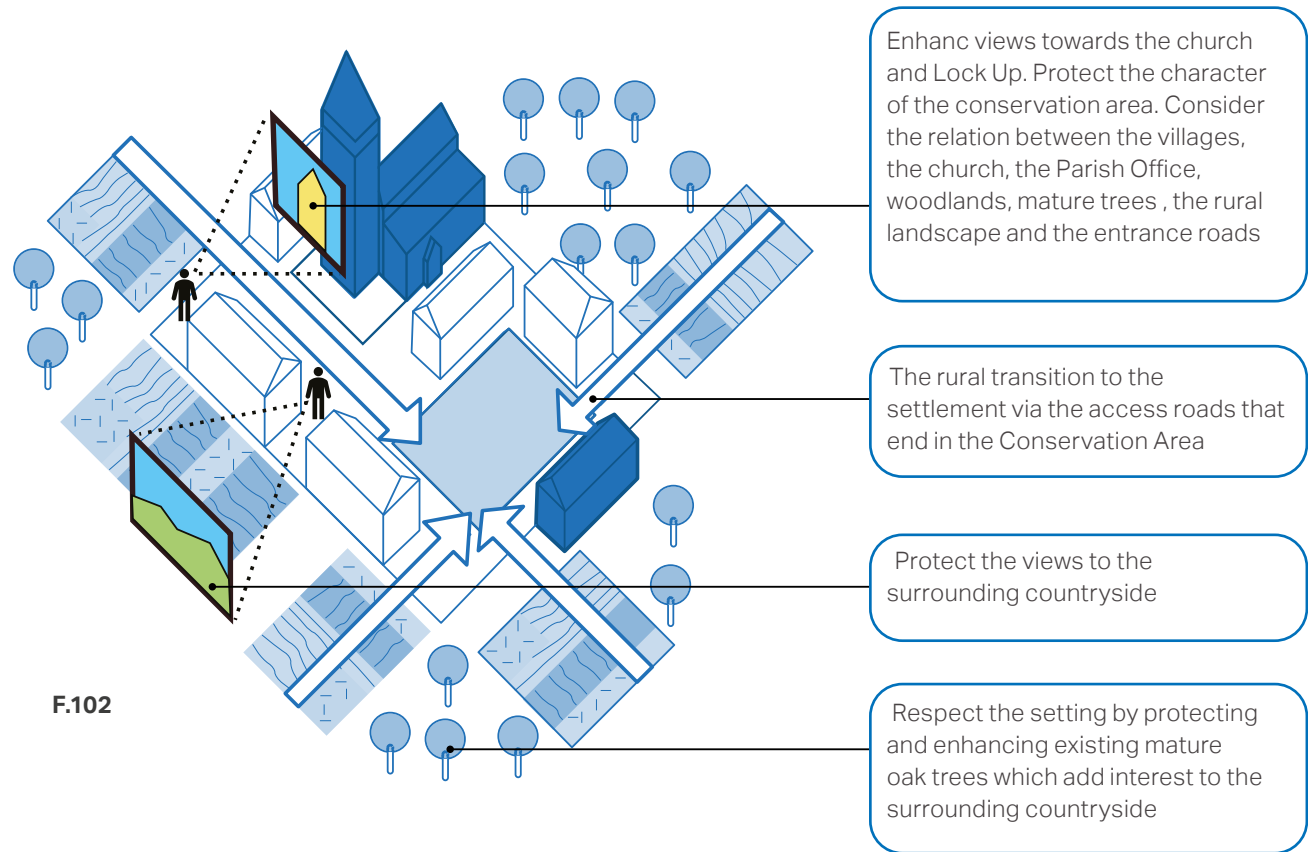

F.102

**Figure 102:** Diagram to illustrate the different components of respecting the setting



## HT 02- Respect the character

There are various architectural styles and diverse traditional materials within the Conservation Area and numerous listed buildings within the Parish.

- Use traditional building materials and feature elements in any new developments, extensions and/ or refurbishment in the area such as red brick, weatherboarding, timber frame, rubble; and
- Encourage the use of current roof styles and materials such as the gabled roof style, slate and tiled materials.



F.103



F.105



F.104

**Figure 103:**  
Respect the character of Wheatley United Reformed Church

**Figure 104:**  
Encourage the use of timbers and rendering on The Avenue

**Figure 105:**  
Mix of red brick and lime stone should be encouraged

# 5 S. Sustainability

Any new housing in Wheatley Parish should mitigate its impact from the loss of countryside, wildlife and the natural environment and demonstrate that it is responding to climate change with the highest standards of insulation and energy conservation.

## SE 01- SUSTAINABLE DRAINAGE SYSTEM (SUDS)

The term SuDS stands for Sustainable Urban Drainage Systems. It covers a range of approaches to managing surface water in a more sustainable way to reduce flood risk and improve water quality whilst improving amenity benefits.

SuDS work by reducing the amount and rate at which surface water reaches a waterway or combined sewer system. Usually, the most sustainable option is collecting this water for reuse, for example in a water butt or rainwater harvesting system, as this has the added benefit of reducing pressure on important water sources.

- All proposals must demonstrate sustainable surface drainage systems that will not unduly increase pressure on existing wastewater and natural drainage systems.
- Gardens and parking areas should have the majority of their area landscaped, with permeable surfacing used on hard landscaped areas to enable rainwater absorption and reduce the rate of run off caused by development.

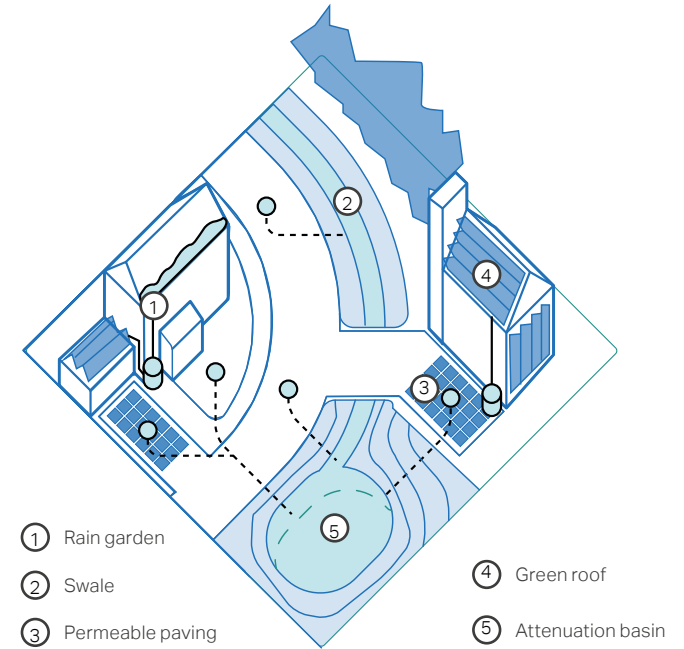

**F.106**

**Figure 106:** Diagram showing the best use of harvesting water systems rain garden, swales, permeable paving, green roofs



**F.107**

**Figure 107:** Examples of SuDS designed as a public amenity and fully integrated into the design of the public realm, Sweden

## SE 02- ENERGY EFFICIENT HOUSING AND ENERGY PRODUCTION

- New development should provide suitable and safe storage for bicycles of sufficient size. At least one secure space should be provided per dwelling in a garage of a suitable size or separate covered area within plot. Covered and secure cycle storage units are preferred but where enclosures are open suitable racks or hoops should be provided.
- Solar, heat recovery, air source and ground source energy is encouraged in new development and should be designed to have a minimal visual impact on a development. Where technologies have a visual impact on sensitive areas (such as solar shingles and photovoltaic slates within or close to the setting of a heritage asset) they should be designed in from the start of the scheme. Designs should aim to conceal wiring and infrastructure and use carefully chosen slates or tiles on

roofs to complement the solar panel materials. Where groups of housing are proposed they should demonstrate energy efficient heating through a combined heat and power system.

- Where existing buildings are being converted or extended every effort should be made to introduce energy saving measures and new technologies to make the building more efficient and sustainable.
  - The use of green or brown roofs and/or living walls is encouraged. These can assist with insulation and summer cooling requirements. They can also be readily integrated with solar systems and have even been shown to increase the efficiency of PV cells on hot summer days.
  - New housing should demonstrate how rainwater and greywater will be stored and reused to make captured water supplies more efficient.
- The installation of water butts within new residential developments is encouraged to collect rainwater from roofs and reduce the overall rainwater run off impact of any development.
  - Whenever possible, developments should aim to re-use existing materials or procure reclaimed and recycled materials from local suppliers. Building materials made from construction and demolition waste are preferred to primary aggregates. Many types of construction waste can be used for these purposes including soil, asphalt, concrete, bricks and tiles. In conversion schemes roof tiles and slates should be carefully stored and re-used. In addition, priority should be given to materials that can be deconstructed and re-used at the end of the building's usable life.

## SE 03- BUILDING ORIENTATION, SOLAR GAIN AND SOLAR SHADING

- The orientation and massing of the building should be optimised if possible to allow useful solar gains and prevent significant overshadowing in winter
- Encourage south facing dwellings with solar shading and prioritise dual aspect
- Overshadowing of buildings should be avoided as it reduces the heat gain from the sun in winter.
- One of the main glazed elevations of future dwellings should keep within 30° of south, when in keeping with the topography and clustering of existing buildings.
- Where it would be inappropriate for the main glazed elevation to be facing south or within 30 degrees of the this for the reason outlined above, every attempt should be made to design the roof so that is of this alignment to allow for the fitting of solar panels This applies to all future dwellings whether solar panels are proposed or not to allow for retrospective implementation.

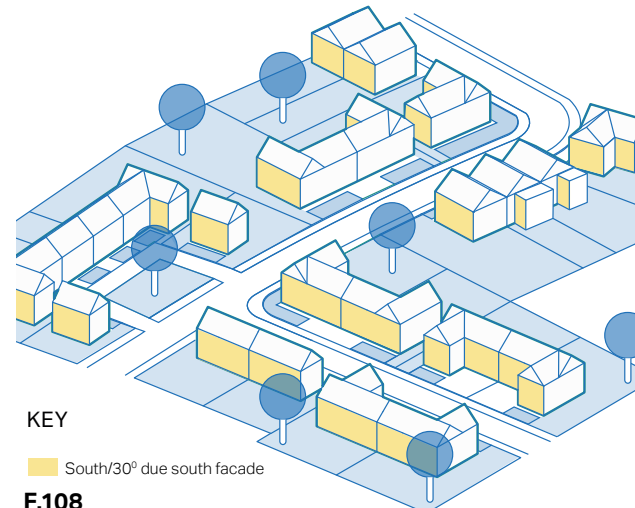

### KEY

■ South/30° due south facade

### F.108

**Figure 108:** Elevations that would benefit from passive solar gain

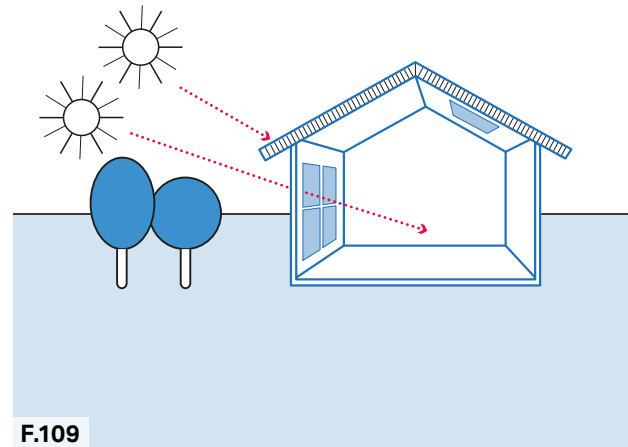

### F.109

**Figure 109:** The use of roof window, pitch roof, location and size of windows in favour of maximising solar gain

## SE 04- BIODIVERSITY

Biodiversity Net Gain (BNG) is an approach to development, and/or land management, that leaves nature in a measurably better state than beforehand. Now a part of UK legislation, BNG is set to become a mandatory consideration, once the Environment Bill has achieved royal ascent, for all development projects in England to demonstrate a 10% increase in biodiversity on or near development sites. As such:

- Existing trees should be retained. All proposed planting should be native species in order to promote biodiversity.
- Gardens and boundary treatments should be designed to allow the movement of wildlife and provide habitat for local species.
- The adoption of swift bricks, bat and owl boxes are encouraged to help provide nesting and roosting spaces or bats and birds.
- Open spaces should be located within walking distance of residential areas and linked through a series of green networks or corridors. Such linkages support a Green Infrastructure approach to development, allowing wildlife

to move along corridors to access foraging opportunities and habitats and people to access a range of different recreational facilities. Where a proposal falls short of these sustainable measures it must be explained why and what compensatory measures are being offered.

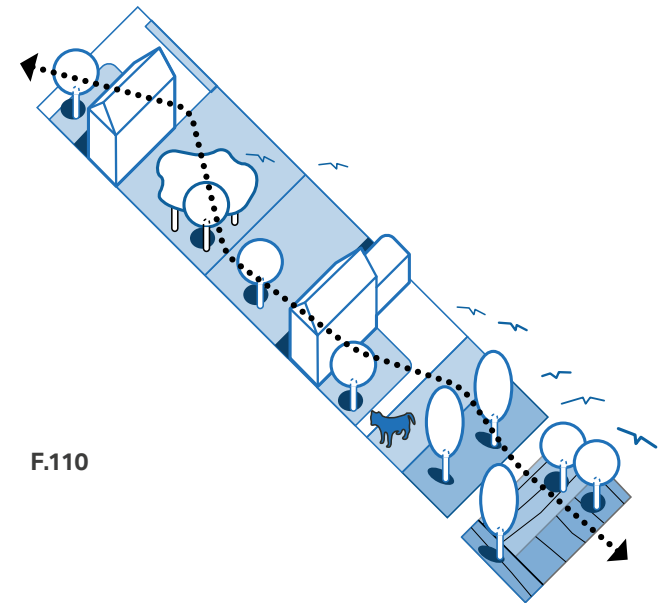

F.110



F.111

**Figure 110:** Diagram to highlight the importance of creating wildlife corridors

**Figure 111:** Improve biodiversity of the village

# 6 VV. Visual variety

## VV 01- TOWNSCAPE

Visual variety can be achieved in the context of the village as a series of spaces, buildings, landscape elements and details that interact to reveal a series of views through gaps, longer or shorter streetscapes and more enclosed lanes and courtyards or squares. It is the differences between features, spaces and building heights that help to add depth and richness to the experience of the village. Gordon Cullen described and promoted this aspect of design theory and the overarching quality of 'Townscape'. He developed studies such as 'serial vision' which described and visual sequences of experience (principally from a pedestrian perspective) of passing through streets and spaces that reveal new scenes and qualities. These types of studies should be used to express development concepts and roles.

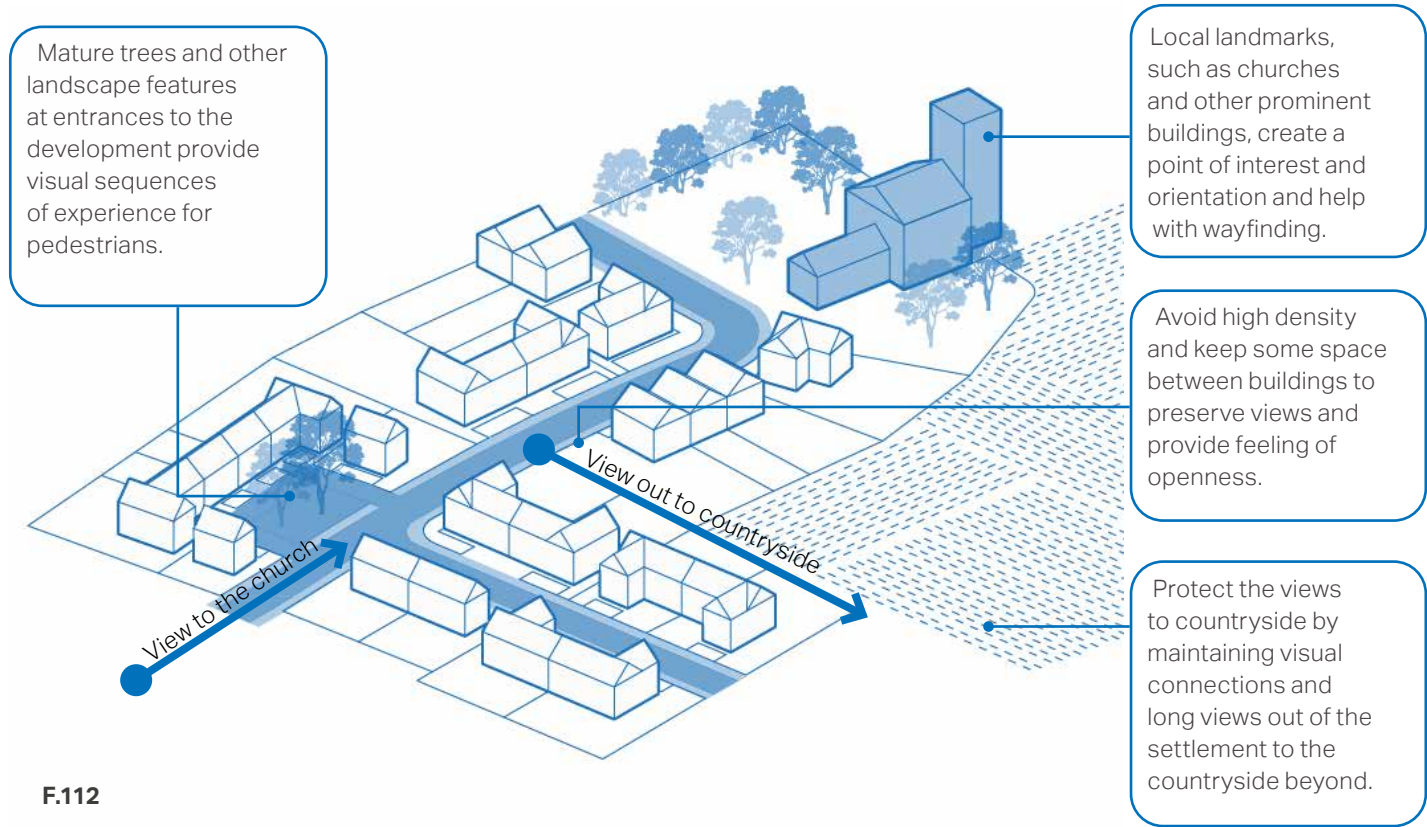

F.112

Figure 112: Diagram showing landmarks and views

05

## VV 02- STREETS, LANES & SPACES

New developments in the village should demonstrate how they integrate with or improve the existing streetscape. Formal town squares or conventional suburban streets are unlikely to add to the right type of visual variety suitable to the village, which is more organic and traditionally has resulted from incremental growth. However, there are still typologies of space, particular street types and patterns such as lanes and courtyards (farmsteads) that can help to get away from standard house builder product with little regard to its context.

## VV 03- HOUSE & BUILDING TYPES

New development in the village should have a story and a connection to the place, its history, its character, buildings and layouts. To extend this existing 'sense of place' with something that is distinctive and high quality but somehow recognisably local and rooted in the village is a key design challenge. A variety of house sizes and building types should be considered to provide variety and diversity within each development whilst also catering to local housing needs. Meeting local housing needs is one way of making a local connection, particularly providing affordable housing which should be indistinct from market specification. New buildings should also refer in form and appearance to those found in the village or in the landscape character area in terms of vernacular forms common to the district.



**F.113**

**Figure 113:** Existing footpath connecting different parts of the village



**F.114**

**Figure 114:** Variety of building types on the High Street

## 7 MC. Movement and connectivity

Safe movement looks at how to create safe, attractive and convenient connections around Wheatley and to the wider area utilising sustainable modes of transport where possible.

Walking and cycling should be encouraged to support growth, limit the negative impacts of traffic congestion on the roads and create direct and memorable routes. In addition, public transport should be used to support active travel and provide improved links between places.

### SM 01- Interconnected street network

Within Wheatley, the High Street and Church Road are heavily used.

- Proposal shall have regards the existing relationship between buildings and the street or other surrounding open spaces and how the siting and position of any new buildings can positively respond to this;

- Minimising the number of culs-de-sac should be encouraged to promote permeability. Also there should be a clear hierarchy of streets to facilitate different levels of activity. Streets should incorporate opportunities for landscaping, green infrastructure and sustainable drainage;
- The design of the street network should respond to the topography and natural desire lines; and
- Proposing short and walkable distances which are usually to be within a 10 minute walk or a 5 mile trip by bike (See WE 01- People-friendly neighbourhood). If the design proposal calls for a new street or cycle/pedestrian link, it must connect destinations and origins providing multiple access points where possible. These will encourage sustainable mode of transport.

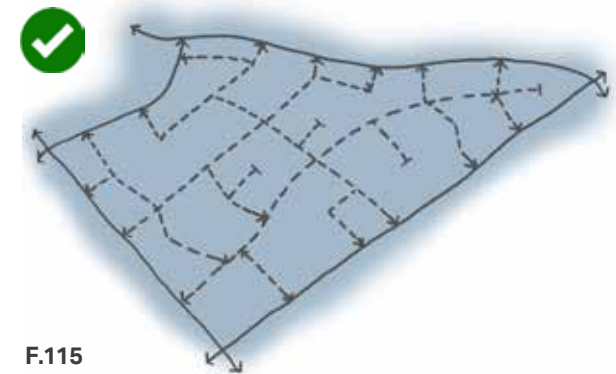

F.115

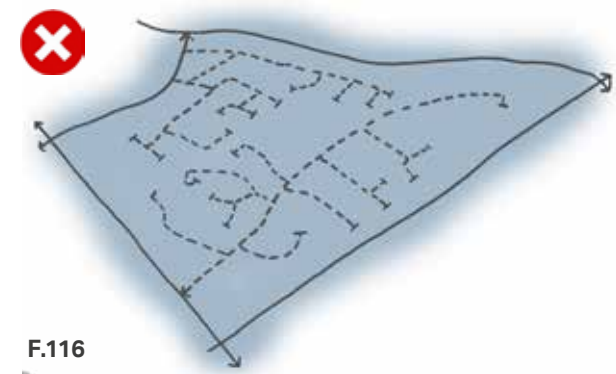

F.116

**Figure 115:**  
A connected layout, with some cul-de-sacs, balances sustainability and security aims in a walkable neighbourhood

**Figure 116:**  
A layout dominated by cul-de-sacs encourages reliance on the car for even local journeys



## 5.5 Specific design codes

The following issues have been identified which should be addressed through new development.

### CODE 1: BLOCK PRINCIPLES

#### 1A - Spatial definition of the public realm

- Development adjoining open spaces and important gaps should enhance the character of these spaces by either providing a positive interface (i.e. properties facing onto them to improve natural surveillance) or a soft landscaped edge;
- Development should not negatively impact on any important views. The topography should be carefully considered when any new buildings are being placed;
- Any trees or woodland lost to new development must be replaced. There should be a non-negative impact on

biodiversity from a new development and a biodiversity net gain of 10% should be aimed for;

- The spacing of new development should reflect the rural character and allow for long distance views of the countryside from the public realm. Trees and landscaping should be incorporated in the design ( Also see Figure 87);
- The existing quiet and peaceful atmosphere of the village should be preserved. Future development should respond to the rural character of the settlements and retain the existing levels of privacy by including hedgerow and tree screening; and
- Landscape schemes should be designed and integrated with the open fields that currently border the settlements.

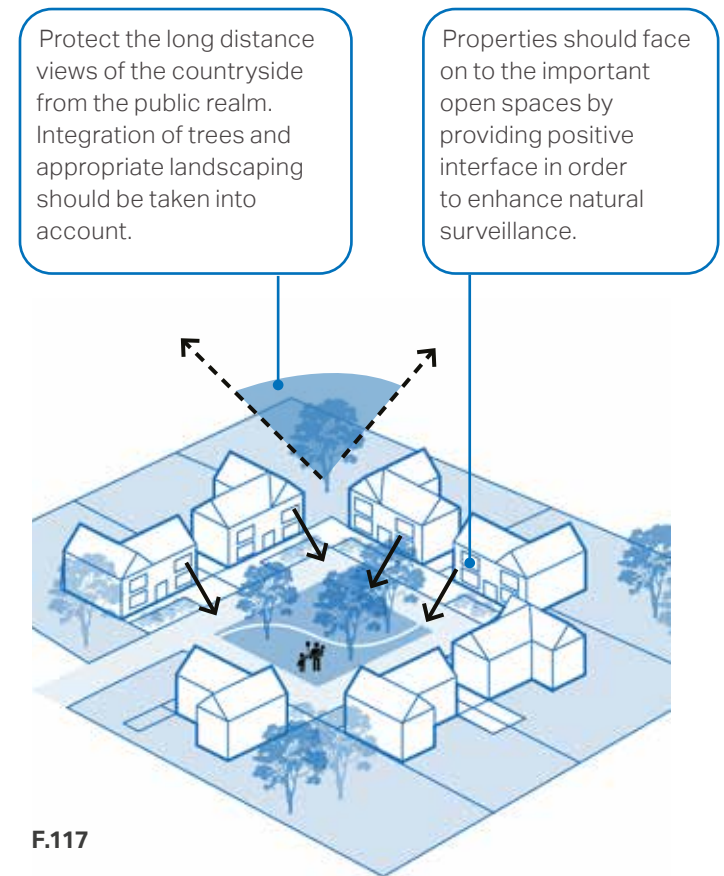

**Figure 117:** Diagram showing green spaces and landscape planting

## 1B - Building line

- Development fronting an existing street should comply with the existing building line – if at the front of the plot – and should have its primary aspect and windows facing the street, particularly if aspects in all other directions is constrained due to overlooking of neighbouring properties. If infill development is at the rear of the plot, this is less relevant.
- To ensure sufficient street enclosure, private front thresholds should have a modest depth and accommodate a small garden or area for plantation; and
- Low to medium density developments in residential areas can vary setbacks in order to respond to the landscape context and the more open character of the area.



F.118

**Figure 118:** Building line follow road layout on the High Street



F.120

**Figure 120:** Building line varied and follow the meandering from of road on Ambrose Rise



F.119

**Figure 119:** Monotonous building line follow road layout in Littleworth Character Area



F.121

**Figure 121:** Varied building lines on The Avenue with deep front garden within the building curtilage

## CODE 2: STREETScape PRINCIPLES

### 2A - Building heights and rooflines

- Development building heights should accord with the settlement character of two storey dwellings;
- Roofs in the village tend to be generally traditionally pitched, with some hipped examples and new roof type and pitch should reflect this. Pitched roofs The use of slate is widespread and should be the main roofing material for new development in the Neighbourhood Plan Area;
- Innovation which explores the integration of green/brown roofs or standing seam roofs should be encouraged. Low quality concrete tiles should be avoided;
- The scale of the roof should always be in proportion to the dimensions of the building itself; Flat roofs for buildings, extensions, garages and dormer windows should be avoided; and Chimney type and height should be congruent with the typical Neighbourhood Area chimney precedent examples.



**F.122**

**Figure 122:** Red tile use on a two storey property with pitched roof style and a chimney stack



**F.123**

**Figure 123:** Two-storey building with pitched roof built with slate

## CODE 3: PARKING AND NATURAL SURVEILLANCE

### 3A - Designing out crime

In order to provide a sense of security and natural surveillance, the windowed front elevation of a dwelling should face the street where this is in keeping with local character. There are some examples within the parish of rear boundaries facing the street. Where possible this should be avoided as this has a negative impact on the character of a street and reduces levels of security and natural surveillance. Rear boundaries should back on to other rear boundaries or provide a soft transition into the natural environment such as at the settlement edge.

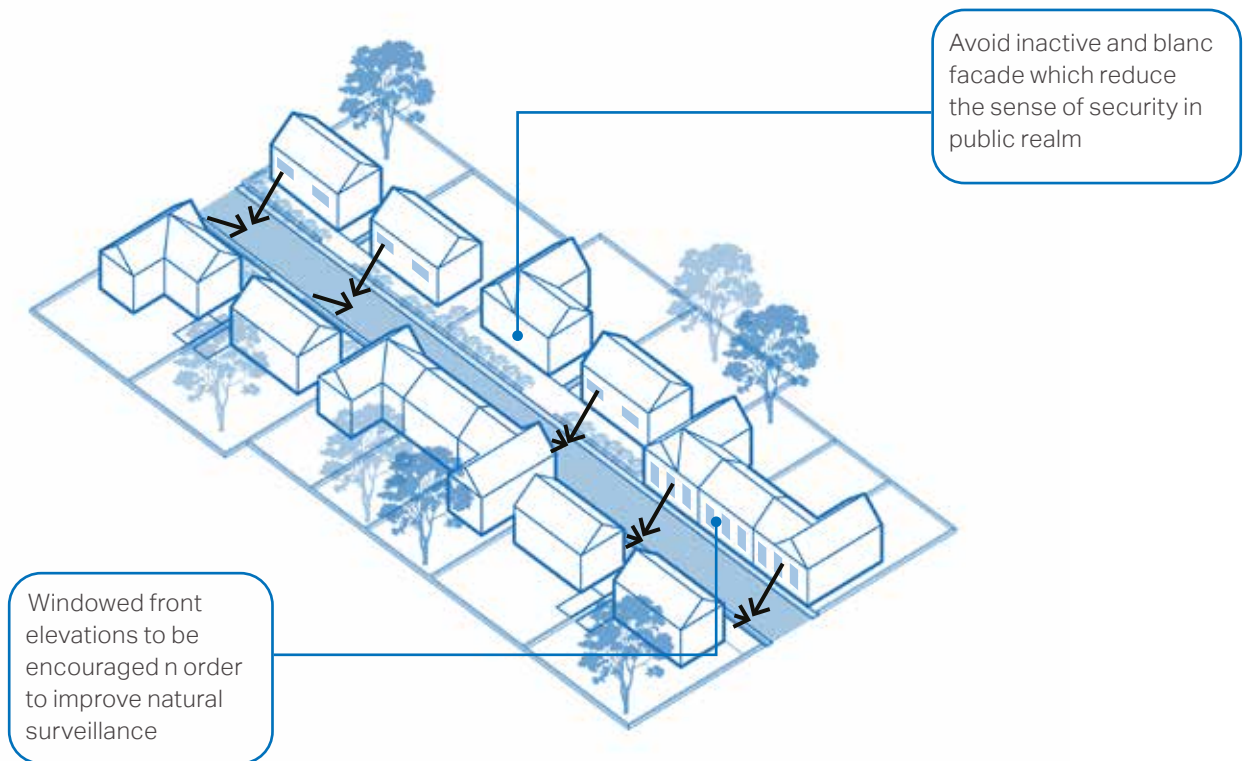

#### F.124

##### Figure 124:

Diagram to highlight the importance of natural surveillance to improve the security

### 3B - Parking solutions

Parking areas are a necessity of modern development. However, they do not need to be unsightly or dominate views towards the house. Parking provision should be undertaken as an exercise of placemaking.

#### On street parking

On-street parking is the only parking option for several dwellings within the Conservation area such as the High Street. In order to reduce the visual impact of parked cars on the street, on-street parking as the only means of parking should be avoided in future development.

- On-street parking must be designed to avoid impeding the flow of pedestrians, cyclists, and other vehicles, and can serve as traffic calming;
- On low-traffic residential streets or lanes that are shared between vehicles and pedestrians, parking bays can be clearly marked using changes in paving materials instead of road markings; and
- Given the move towards electric vehicles, every opportunity must be taken to integrate charging technologies into the fabric of road and street furniture in the public and private realm.

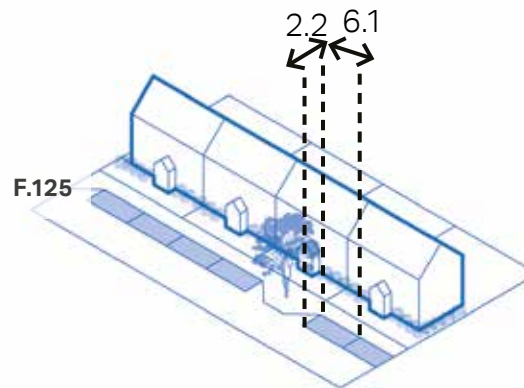

**Figure 125:**  
Illustrative diagram showing an indicative layout of on-street parking

**Figure 126:**  
On-street parking on the High Street

**Figure 127:**  
Inset on-street parking with electric vehicle charging points

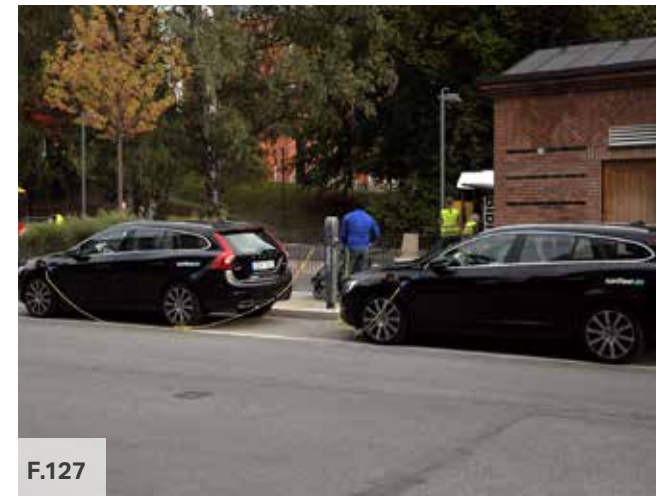

## On-plot side or front parking

- Parking provided on driveways directly in front of dwellings should be restricted due to the visual impact that cars have on the street. Therefore, a maximum of 2 dwellings in a row will be permitted to provide parking in this way. Front gardens should be a minimum depth of 6m to allow movement around parked vehicles and also be well screened with hedgerows when providing parking space to the front of a dwelling.
- Parking being provided on a driveway to the side of a dwelling should be of sufficient length (5m minimum) so that a car can park behind the frontage line of the dwelling. This will reduce the visual impact that cars will have on the street scene. When parking is provided to the side of a dwelling a minimum front garden depth of 3m should be provided,

**Figure 128:**  
Illustrative diagram showing an indicative layout of on-plot side parking

**Figure 129:**  
An example of on-plot side parking in the village

**Figure 130:**  
Illustrative diagram showing an indicative layout of on-plot front parking

**Figure 131:**  
On-plot car parking in The Avenue Character Area

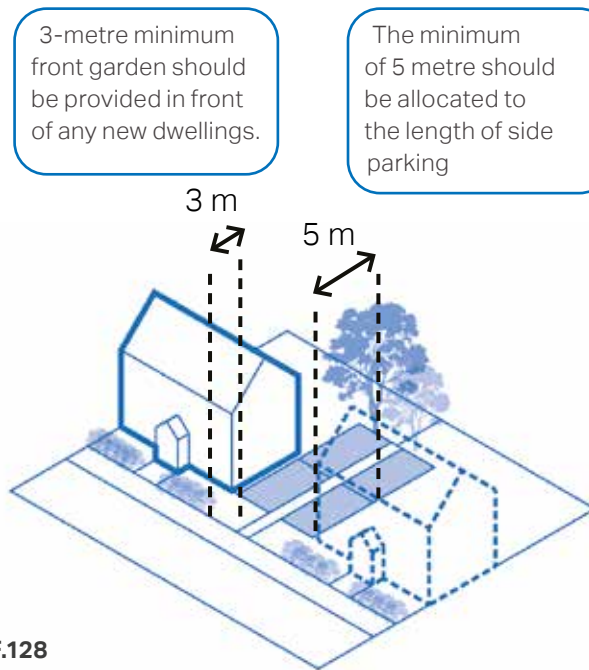

F.128

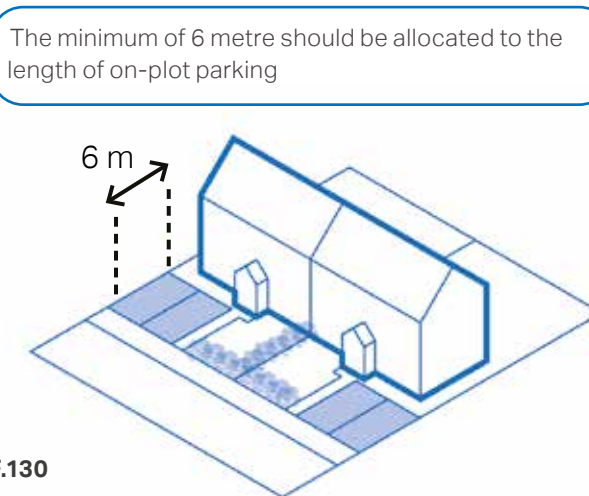

F.130



F.129



F.131

## Garage parking

Parking being provided in a garage to the side of a dwelling should be in line with, or slightly set back from the frontage line of the existing dwelling, which is in keeping with the character of the existing village and will reduce the visual impact of cars on the street. Garages should also provide sufficient room for cars to park inside them as well as provide some room for storage. The minimum internal dimensions of a garage should therefore be 6m x 3m.

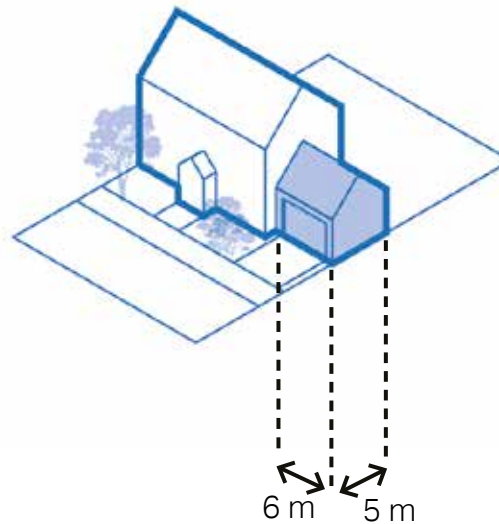

F.132

The internal dimensions of a garage should be 6m x 5m

**Figure 132:**  
Illustrative diagram showing an indicative layout of on-plot garage parking



F.133

**Figure 133:**  
On-plot garage parking in Littleworth Character Area (CA3)

## CODE 4: PLOT PRINCIPLES

### 4A - Backland development / plot infill

Backland development or plot infill (See “SL 03- Infill” on page 77) is development on land of an existing dwelling. This sort of development has the potential to cause issues for existing residents including loss of privacy, daylight and parking problems.

In the case of Wheatley, there have been some recent instances of backland development that has been out of context, both in terms of their scale, form and material palette. There is a risk that this sort of developments will continue to come forward in a way that is out of context and scale development.

Appendix 1 of the WNP sets out more detail on the history and character of the village, along with some information on the architectural character. In addition to this, proposed backland development should also ensure that the spacing requirements set out within the coding (See Figure 150) are

**Figure 134:**  
Diagram showing backland development

maintained and that the density, scale and appearance of the development reflects its immediate context and reduces impacts to the amenity of existing properties.

Tandem development is a form of backland development where a new dwelling is placed immediately behind an existing dwelling and served by the same vehicular access. Tandem developments will generally be unacceptable due to the impact on the amenity of the dwelling at the front of the site.

Based on South Oxfordshire Local Plan 2011-2035 (See “2.2 Key policy and guidance” on page 16), where a proposal encompasses residential development of land behind an existing frontage or placing of further dwellings behind existing dwellings within the site, the proposal should demonstrate the privacy of existing and future residents means of access, and it should not extend the limit of settlements.

**Figure 135:**  
Diagram showing tandem development which will generally be unacceptable due to unacceptable erosion of privacy and amenity

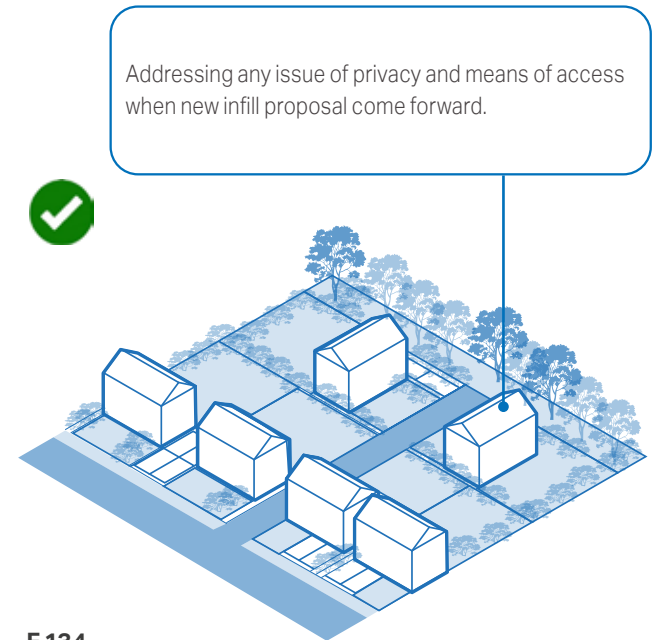

F.134

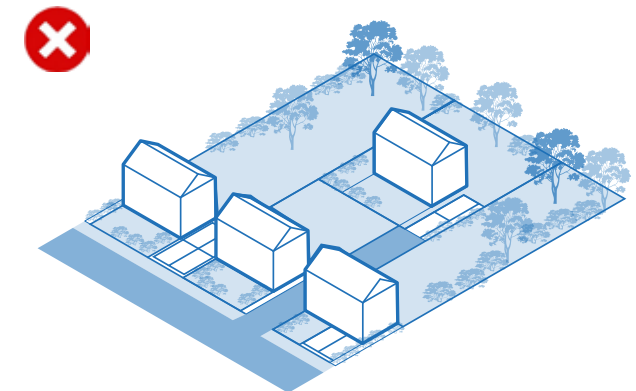

F.135



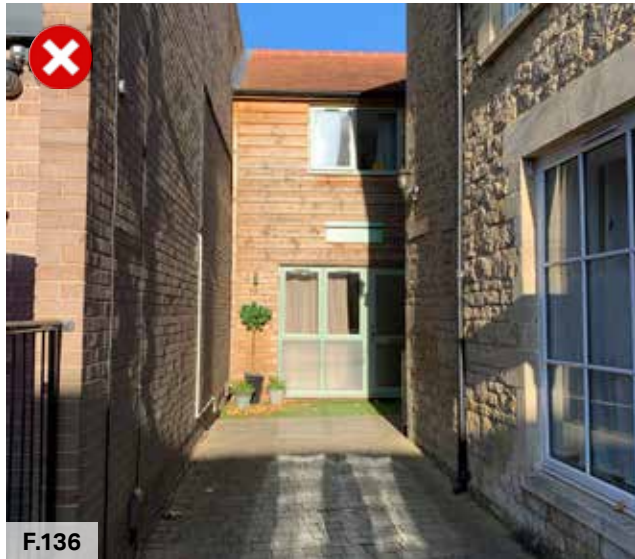

**Figure 136:** Unsympathetic example of tandem development. Erection of new two storey bedroom with provision of enclosed bin store

**Figure 137:** An unsympathetic example of infill development on the High Street. View to the front door of Shoe Box and the bike shed

**Figure 138:** Positive two-storey development on Church Road. This type of infill can be considered if adequate parking allocated

**Figure 139:** A positive example of infill development on the High Street. The use of impermeable drives should be avoided

**Figure 140:** An unsympathetic example of infill development on the High Street



**Figure 141:** A positive example of infill development using the local material in keeping with local vernacular (Courtesy of Wheatley Parish Council)

**Figure 142:** An unsympathetic example of new development not in keeping with the local architecture style and local materials in Ambrose Rise Character Area

**Figure 143:** Unsympathetic use of materials and building typology

**Figure 144:** Unsympathetic example of backland development in The Avenue Character Area and just in the land of Homes Fit for Heroes. Planning permission has been given to demolition of existing garage structure and erection of 2 bed single storey bungalow



F.145



F.147



F.148

**Figure 145:** Exploitation of generous garden space. 4 x two storey houses in a mainly "bungalow area" on Acremead Road. The planning application refused on 26th July 2021 (Courtesy of Wheatley Parish Council)

**Figure 146:** A negative example of infill development which become house heavy site for family home with little garden space on Windmill Lane (Courtesy of Wheatley Parish Council)

**Figure 147:** An unsympathetic example of inappropriate materials within the village

**Figure 148:** A positive mix use of local materials such as limestone on wall and tile for the pitched roof



F.146

Infill plot development should take precedent from good examples within the surrounding architectural context. Poor contextual precedent should not set the standard. Therefore, the code stipulates that this type of development within the existing built-up form of Wheatley will be supported if it adheres to the following principles:

### Setting and character

Infill development should complement the street scene and rural setting into which it will be inserted.

### Building pattern

This refers to the sizes of plots and the position of houses within those plots. Ensure all new development aligns with the spatial layout and pattern of the village.

### Scale and massing

The height of development should take into consideration the surrounding context. The scale of any infill or backland development

should be informed by adjacent dwellings within the streetscene.

In general, future development should adhere to a maximum height of two storeys.

Where appropriate, the first floor can be set back from the street frontage to reduce the impact of the building on the streetscene.

It is acceptable for a dwelling to provide an additional storey within the roof space and use sky lights and/or gable end windows.

### Ratio of private green space

The ratio of garden space to built form within the overall plot is exceptionally important to ensure that the sense of openness and green space within the village is maintained.

There are different garden dimensions in each of the character areas. In CA1, the front garden proportions range from 0 to 5 m and the back garden are between 7 till 60 with the latter found mainly on Crown Lane. CA5 and CA7 have spacious front garden (15m) with around 30m length for back garden.

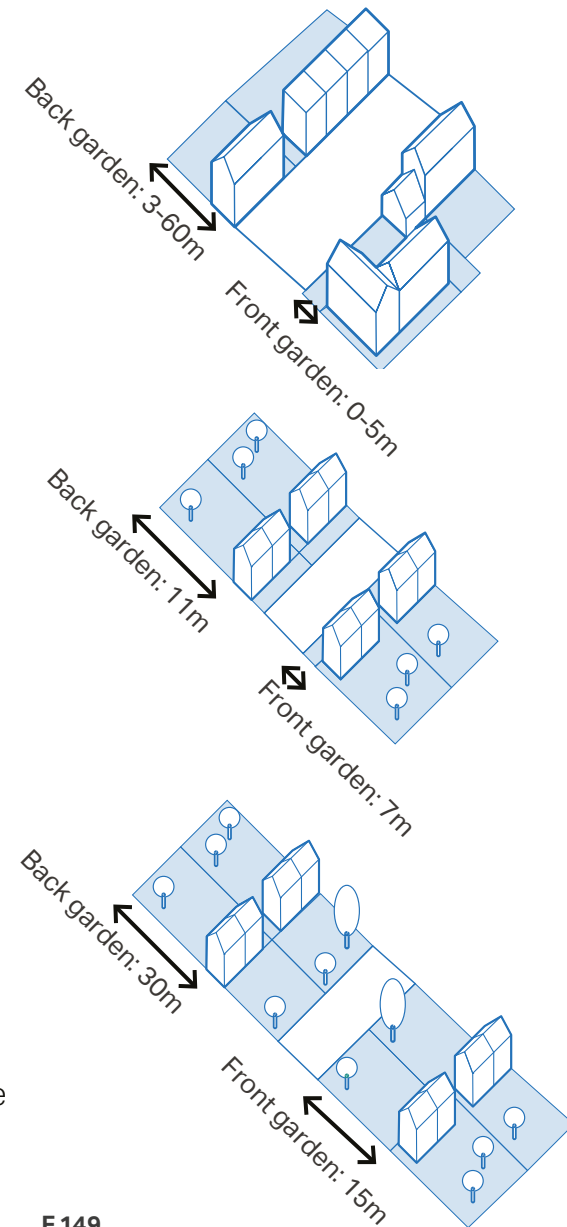

F.149

Figure 149: Different proportion of green space varied. From top (The High Street), middle (Ambrose Rise) and bottom (The Avenue)

CA2 and CA4 which are located to the edge of the NP area have more generous garden space with the average of 15 and 20m for front and back gardens, respectively.

Back gardens should be a minimum depth of 10m and provide a minimum area of 50m<sup>2</sup> of usable amenity space.

North facing back gardens should exceed 10m in length to ensure sunlight is maximised.

### Plot boundary line

Front boundaries should respond to the boundaries used within adjacent dwellings to provide continuation of street character. Appropriate boundary choices are illustrated in the form of low wall either built by stone or red brick. Use of hedges are predominant in village as boundary treatment.

When rear boundaries abut the settlement edge, surrounding landscape or open green spaces, soft planted boundaries of hedgerows and trees must be used to soften

the transition into the natural environment and protect views.

### Privacy and space between buildings

Any proposed backland or infill development must not cause an unacceptable impact on the residential amenities of adjacent residential properties.

Hedges and fences usually protect privacy at ground floor level, so any privacy issues tend to arise from upstairs windows either looking into neighbours' windows or down into their private garden space.

To avoid overlooking of habitable rooms and gardens a minimum distance of 15m should be achieved between dwellings where a side elevation of one dwelling faces a rear elevation of another. Where a side elevation is windowless the separation distance can be reduced to 12m. A minimum separation distance of 21m should be achieved between facing windowed rear elevations.

Where dwellings with facing elevations are positioned on different levels, the above

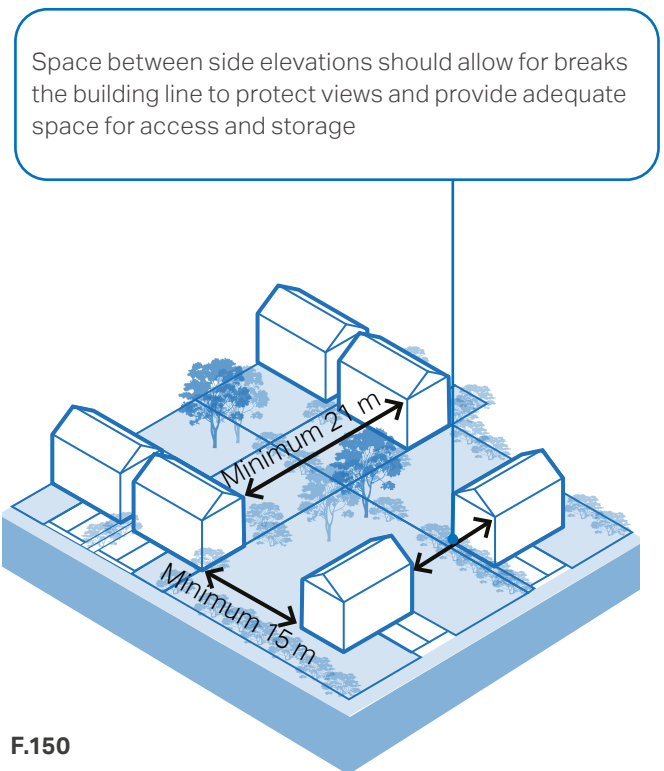

F.150

**Figure 150:** Diagram showing privacy and space between buildings

separation distances should be increased by 2m for every 1m difference in level. Where there is a level difference and distances are increased, the lower dwelling should have the longer garden to compensate for any slopes or retaining structures.

Future housing developments should design the spacing between dwellings to allow for retrospective introduction of garden and cycle storage as well sustainable measures such as air source heat pumps.

### Building roofline

The scale of the roof should always be in proportion to the dimensions of the main dwelling. Flat roofs should be avoided for all infill development buildings, extensions, dormer windows and garages. Chimney type and height should be congruent with the typical Neighbourhood Area chimney precedent examples

### Green infrastructure

Where appropriate, green roofs can be considered to ensure no net loss of green cover and to enhance biodiversity and urban

greening.

Green roofs improve drainage and add to biodiversity. Whether the roof is partially or completely covered with vegetation, their design should follow some design principles such as:

- Planned from the start.
- Easy to reach and maintain.
- To complement (where applicable) the surrounding landscape.
- To help integrate the building with the countryside.
- Design comprehensively with other eco designs such as water harvesting and porous pavements.

### Access

Infill sites are often narrow, making it difficult to provide adequate access, on-site turning (where necessary) and parking. The proposed development provides appropriate access, parking and turning arrangements. An integral garage can save space, and sometimes it's possible to share a drive with a neighbour.



F.151



F.152

**Figure 151:**  
Modern building with green roof and facade

**Figure 152:**  
Varied roofline along the High Street. The majority of buildings are pitched in the village

## 4B - Building modifications and extensions

Extensions to dwellings can have a significant impact not only on the character and appearance of the building, but also on the street scene within which it sits. A well-designed extension can revitalise an older building and enhance the appearance of its street, whereas an unsympathetic extension can have a harmful impact, create problems for neighbouring residents and affect the overall character of the area.

The Planning Portal contains more detailed information on building modifications and extensions, setting out what is usually permitted without planning permission (permitted development) as well as what requires planning permission. Some general principles of building modifications and extensions within the village can be found below:

- Extensions must be appropriate to the scale, massing and design of the main building, and should complement both

the streetscape and the rural setting. The general size, height and width of the extension should normally be less than the original building, ensuring that it remains similar or subordinate to the original building in terms of scale and form.

The original building should remain the dominant element of the property regardless of the number of extensions.

- Alterations and extensions of historic buildings within the Conservation Area should preserve and where possible, enhance the character of the Conservation Area.
- Two-storey extensions, where appropriate, should be constructed with a pitch sympathetic to that of the existing roof.
- Consider the appropriate building methods, colours and architectural styles for the extension. These can be traditional or contemporary as

long as they complement the original building and local character. It may be most appropriate for extensions on significant or notable buildings to be clearly different from the original building. This can allow the merits of the original building to stand out. However such a decision should always be based on an understanding of the building's character.

- The impact on the space around the building should avoid overlooking, overshadowing, or overbearing.
- On a two-storey building the conservatory should normally be no higher than the underside of first floor sills of the original building. It is usually preferable to locate conservatories on the rear of the house but on larger plots the side may be suitable also.
- Sheds, garages and other outbuildings should not compete, in terms of scale, decoration and design, with the original buildings they serve. They should be designed and sited to relate to, not

dominate, the original building. Use of more subdued colours and simple designs will allow them to be less obtrusive.

- Some decoration may be appropriate if this helps reflect the character of the main building. Garages should generally be set behind the building line or at 90° to the street.

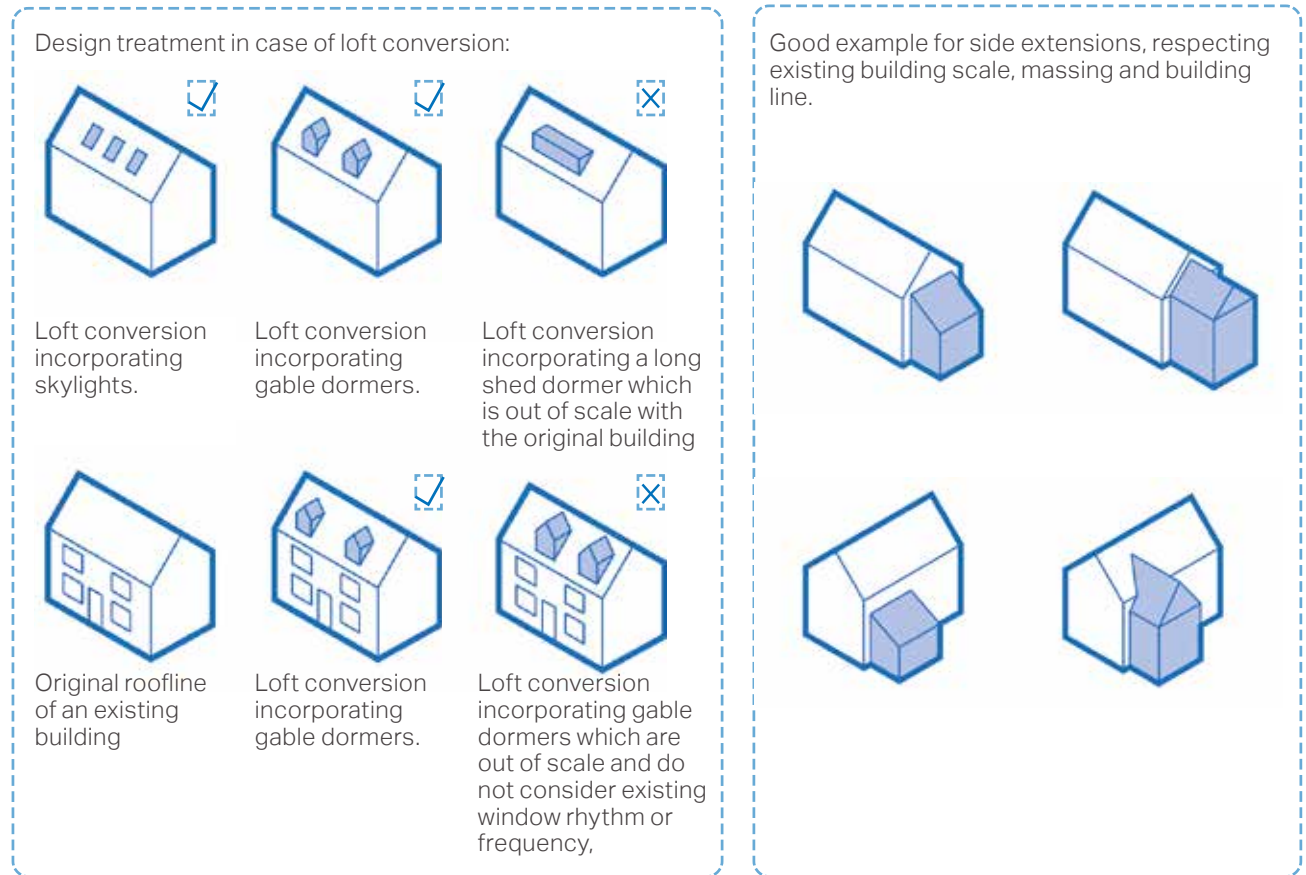

F.153

**Figure 153:** Some examples for different type of building extensions



## Code 5: Building principles

### 5A - Architectural details

There are diverse architectural styles in the parish ranging from Victorian Design such as the Parish Church and the Schoolhouse to Tudorbethan Style such as houses on The Avenue. In the past, Wheatley had several windmills, some dating back to the 17th century, but now only one remains. Pitched roofs are predominant in the village.

- New developments should encourage and support innovative and proactive approaches to design and opportunities to deliver decentralised energy systems powered by a renewable or low carbon source and associated infrastructure, including community-led initiatives; and
- New developments should strive for good quality design that meets climatic targets for CO2 emissions and that can be constructed sustainability maximising opportunities for recycling.



F.154



F.156



F.155

**Figure 154:**  
Church of St Mary's built in Victorian style

**Figure 155:**  
Bungalow with pitched roof on Keydale Road in Littleworth Character Area

**Figure 156:**  
Semi-detached houses on The Avenue built in Tudorbethan Style



**Figure 157:**  
View to a the windmill on Windmill Lane in Ladder Hill Character Area

**Figure 158:**  
A property with mix of stone and red brick on Kiln Lane

**Figure 159:**  
A row of terraced houses along High Street

**Figure 160:**  
Three- storey Flats with white weatherboarding on Beech Road

## 5B- BUILDING VERNACULAR

As previously stated, the special character of buildings in Wheatley Conservation Area arises from the mixture of local limestone and warm red brick and tile, alongside slate.

Informed by the local vernacular, the following pages illustrates acceptable materials and detailing for future housing developments in Wheatley. The use of traditional construction finishes should be specified for all new development and repair work. Material specification quality for repair, replacement and modern developments should be maintained. The requirement for additional housing in the village should not trump architectural quality and character of the area.

Future developments should carefully apply this code to avoid creating a pastiche of the existing local vernacular. Detailing can be interpreted using contemporary methods to avoid this.

In the case of a conversion of an existing historic building into a residential use, this should look to preserve and enhance any existing heritage features, to maintain the integrity of the original building. Any new fenestration should be positioned carefully to maintain the character and balance of the building and reflect the existing design through use of complementary materials and finishes. These buildings create the opportunity to provide large single dwellings or can be split into a series of smaller dwellings

Wall



**Limestone**



**Timber frame and yellow render**



**Roughcast**



**Warm red brick**



**Painted stone**

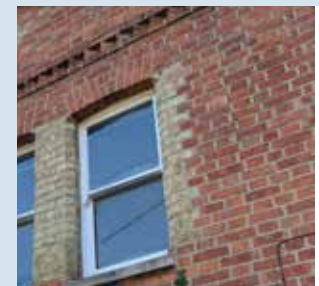

**Mix of red and yellow brick**

Fenestration



Bay window



Casement window



Dark brown wooded door



Gabled porch with wooden entrance door



Wooden door



Sash window

Roof



Slate



Gabled dormer



Bargeboards



Red tile



Chimney stack with red brick



Hipped roof with tile

Colour palette



## CODE 6: INDUSTRIAL ESTATE PRINCIPLES

The guidelines aim to guide any potential development in close proximity to the industrial estate.

### 6A- LAYOUT AND BUILDING APPEARANCE

- The road network should be laid out to facilitate the circulation within the industrial estate;
- Proposals for new industrial developments should avoid the creation of access conflicts with the surrounding residential areas;
- Building layout should optimise the use of land according to the proposed land use, whilst ensuring the other design guidelines contained within this document are not compromised;
- Building height and mass should not create abrupt changes in proximity to existing residential areas, but should

be integrated within the surrounding context;

- The design of new buildings in the industrial area should be consistent in scale with nearby industrial buildings;
- New developments should be attractively designed and use high quality contemporary building forms and materials; and
- Parking should not dominate the area and should be screened by vegetation and mature trees and, where possible, be located to the rear of buildings.

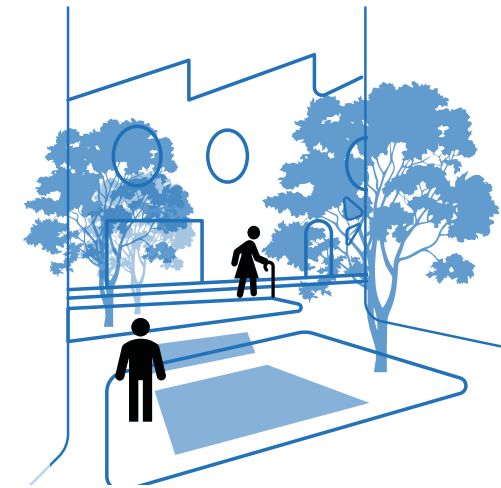

F.161

**Figure 161:** Design public spaces and meeting places, avoid creating new low quality green space at the edge of an industrial site

## 6B- VIEWS AND CONNECTIONS WITH THE COUNTRYSIDE

- Landscape buffer zones should be provided between the residential and the industrial area to soften the visual impact of the new developments;
- Potential views towards the open countryside should not be obstructed by new industrial buildings;
- Landscape screening and building orientation should be used to minimize the visual impact of new development over the surrounding settlement and countryside; and
- The general design of the development should maintain and enhance view corridors from and to the site, potential focal points and gateway functions. Potential focal point should be considered on London Road when approaching the Industrial Character Area.

## 6C- BOUNDARY TREATMENT

- Buildings should be well set back from main roads to provide opportunity for landscape planting to improve the visual quality of the streetscape;
- Boundary treatment for new developments should be designed to frame the building and improve the overall streetscape; and
- Plot boundaries should be screened with native vegetation or other landscape design solutions.

## 6D- MATERIALS

- A common material palette should be adopted and used throughout the area to provide a unified and identifiable image of the industrial area; and
- Light and/or neutral colours should be used on industrial buildings to help reduce their perceived size into the surrounding landscape.

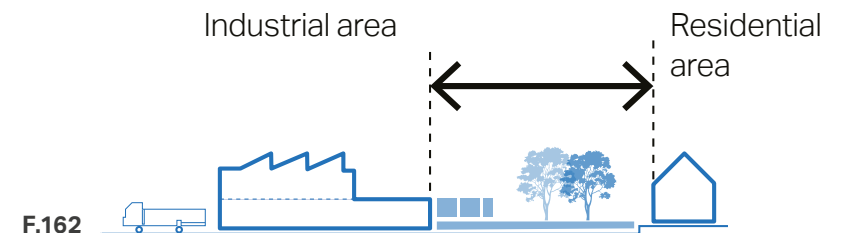

**Figure 162:** Use ancillary uses and landscaping to provide a buffer between residential and industrial uses

**Checklist**

**06**



# 6. Checklist

## 6.1 General questions to ask when presented with a development proposal

Because the design guidance and codes in this document cannot cover all design eventualities, this chapter provides a number of questions based on established good practice against which the design proposal should be evaluated. The aim is to assess all proposals by objectively answering the questions below. Not all the questions will apply to every development. The relevant ones, however, should provide an assessment as to whether the design proposal has considered the context and provided an adequate design solution.

As a first step there are a number of ideas or principles that should be present in all proposals. These are listed under 'General design guidance for new development'. Following these ideas and principles, several questions are listed for more specific topics on the following pages.



# 1

## General design guidelines for new development:

- Integrate with existing paths, streets, circulation networks and patterns of activity;
- Reinforce or enhance the established settlement character of streets, greens, and other spaces;
- Harmonise and enhance existing settlement in terms of physical form, architecture and land use;
- Relate well to local topography and landscape features, including prominent ridge lines and long-distance views;
- Reflect, respect, and reinforce local architecture and historic distinctiveness;
- Retain and incorporate important existing features into the development;
- Respect surrounding buildings in terms of scale, height, form and massing;
- Adopt contextually appropriate materials and details;
- Provide adequate open space for the development in terms of both quantity and quality;
- Incorporate necessary services and drainage infrastructure without causing unacceptable harm to retained features;
- Ensure all components e.g. buildings, landscapes, access routes, parking and open space are well related to each other;
- Positively integrate energy efficient technologies;
- Make sufficient provision for sustainable waste management (including facilities for kerbside collection, waste separation, and minimisation where appropriate) without adverse impact on the street scene, the local landscape or the amenities of neighbours;
- Ensure that places are designed with management, maintenance and the upkeep of utilities in mind; and
- Seek to implement passive environmental design principles by, firstly, considering how the site layout can optimise beneficial solar gain and reduce energy demands (e.g. insulation), before specification of energy efficient building services and finally incorporate renewable energy sources.

## 2

### Street grid and layout:

- Does it favour accessibility and connectivity? If not, why?
- Do the new points of access and street layout have regard for all users of the development; in particular pedestrians, cyclists and those with disabilities?
- What are the essential characteristics of the existing street pattern; are these reflected in the proposal?
- How will the new design or extension integrate with the existing street arrangement?
- Are the new points of access appropriate in terms of patterns of movement?
- Do the points of access conform to the statutory technical requirements?

## 3 (continues)

### Local green spaces, views & character:

- What are the particular characteristics of this area which have been taken into account in the design; i.e. what are the landscape qualities of the area?
- Does the proposal maintain or enhance any identified views or views in general?
- How does the proposal affect the trees on or adjacent to the site?
- Can trees be used to provide natural shading from solar gain? i.e. deciduous trees can limit solar gains in summer, while maximising them in winter.
- Has the proposal been considered within its wider physical context?
- Has the impact on the landscape quality of the area been taken into account?
- In rural locations, has the impact of the development on the tranquillity of the area been fully considered?
- How does the proposal impact on existing views which are important to the area and how are these views incorporated in the design?
- How does the proposal impact on existing views which are important to the area and how are these views incorporated in the design?
- Can any new views be created?
- Is there adequate amenity space for the development?
- Does the new development respect and enhance existing amenity space?

# 3

## Local green spaces, views & character:

- Have opportunities for enhancing existing amenity spaces been explored?
- Will any communal amenity space be created? If so, how this will be used by the new owners and how will it be managed?
- Is there opportunity to increase the local area biodiversity?
- Can green space be used for natural flood prevention e.g. permeable landscaping, swales etc.?
- Can water bodies be used to provide evaporative cooling?
- Is there space to consider a ground source heat pump array, either horizontal ground loop or borehole (if excavation is required)?

# 4

## Gateway and access features:

- What is the arrival point, how is it designed?
- Does the proposal maintain or enhance the existing gaps between settlements?
- Does the proposal affect or change the setting of a listed building or listed landscape?
- Is the landscaping to be hard or soft?

# 5 (continues)

## Buildings layout and grouping:

- What are the typical groupings of buildings?
- How have the existing groupings been reflected in the proposal?
- Are proposed groups of buildings offering variety and texture to the townscape?
- What effect would the proposal have on the streetscape?
- Does the proposal maintain the character of dwelling clusters stemming from the main road?
- Does the proposal overlook any adjacent properties or gardens? How is this mitigated?
- Subject to topography and the clustering of existing buildings, are new buildings oriented to incorporate passive solar design principles?

## 5 (continued)

### Buildings layout and grouping:

- If any of the buildings were to be heated by an individual air source heat pump (ASHP), is there space to site it within the property boundary without infringing on noise and visual requirements?
- Can buildings with complementary energy profiles be clustered together such that a communal low carbon energy source could be used to supply multiple buildings that might require energy at different times of day or night to reduce peak loads? And/or can waste heat from one building be extracted to provide cooling to that building as well as heat to another building?

## 6

### Building line and boundary treatment:

- What are the characteristics of the building line?
- How has the building line been respected in the proposals?
- Has the appropriateness of the boundary treatments been considered in the context of the site?

## 7

### Buildings layout and grouping:

- What are the characteristics of the roofline?
- Have the proposals paid careful attention to height, form, massing and scale?
- If a higher than average building(s) is proposed, what would be the reason for making the development higher?
- Will the roof structure be capable of supporting a photovoltaic or solar thermal array either now, or in the future?
- Will the inclusion of roof mounted renewable technologies be an issue from a visual or planning perspective? If so, can they be screened from view, being careful not to cause over shading?

# 8

## Household extensions:

- Does the proposed design respect the character of the area and the immediate neighbourhood, and does it have an adverse impact on neighbouring properties in relation to privacy, overbearing or overshadowing impact?
- Is the roof form of the extension appropriate to the original dwelling (considering angle of pitch)?
- Do the proposed materials match those of the existing dwelling?
- In case of side extensions, does it retain important gaps within the street scene and avoid a 'terracing effect'?
- Are there any proposed dormer roof extensions set within the roof slope?
- Does the proposed extension respond to the existing pattern of window and door openings?
- Is the side extension set back from the front of the house?
- Does the extension offer the opportunity to retrofit energy efficiency measures to the existing building?
- Can any materials be re-used in situ to reduce waste and embodied carbon?

# 9 (continues)

## Building materials and surface treatment:

- What are the characteristics of the roofline?
- Have the proposals paid careful attention to height, form, massing and scale?
- If a higher than average building(s) is proposed, what would be the reason for making the development higher?
- Will the roof structure be capable of supporting a photovoltaic or solar thermal array either now, or in the future?
- Will the inclusion of roof mounted renewable technologies be an issue from a visual or planning perspective? If so, can they be screened from view, being careful not to cause over shading?

## 9 (continued)

### Building materials and surface treatment:

- Are recycled materials, or those with high recycled content proposed?
- Has the embodied carbon of the materials been considered and are there options which can reduce the embodied carbon of the design? For example, wood structures and concrete alternatives.
- Can the proposed materials be locally and/or responsibly sourced? E.g. FSC timber, or certified under BES 6001, ISO 14001 Environmental Management Systems?

## 10

### Car parking:

- What parking solutions have been considered?
- Are the car spaces located and arranged in a way that is not dominant or detrimental to the sense of place?
- Has planting been considered to soften the presence of cars?
- Does the proposed car parking compromise the amenity of adjoining properties?
- Have the needs of wheelchair users been considered?
- Can electric vehicle charging points be provided?
- Can secure cycle storage be provided at an individual building level or through a central/ communal facility where appropriate?
- If covered car ports or cycle storage is included, can it incorporate roof mounted photovoltaic panels or a biodiverse roof in its design?

# 11

## Architectural details and design:

- If the proposal is within a conservation area, how are the characteristics reflected in the design?
- Does the proposal integrate with the adjacent properties? This means that it follows the height massing and general proportions of adjacent buildings and how it takes cues from materials and other physical characteristics.
- Does the proposal maintain or enhance the existing landscape features?
- Has the local architectural character and precedent been demonstrated in the proposals?
- If the proposal is a contemporary design, are the details and materials of a sufficiently high enough quality and does it relate specifically to the architectural characteristics and scale of the site?
- Is it possible to incorporate passive environmental design features such as larger roof overhangs, deeper window reveals and/or external louvres/shutters to provide shading in hotter months?
- Can the building designs utilise thermal mass to minimise heat transfer and provide free cooling?
- Can any external structures such as balconies be fixed to the outside of the building, as opposed to cantilevering through the building fabric to reduce thermal bridge?

Delivery  
**07**

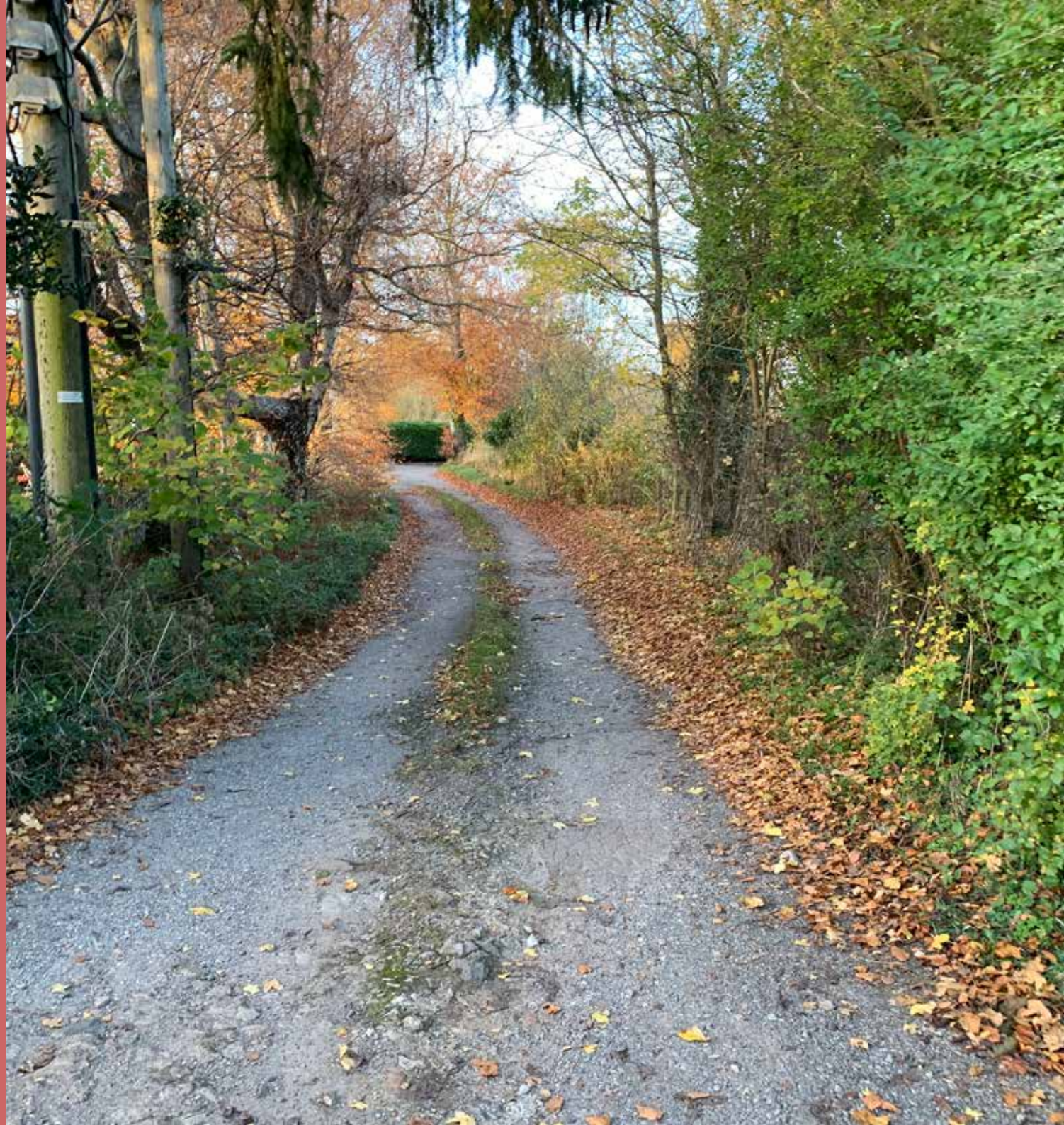



# 7. Delivery

This document has set out an evidence base for the Wheatley Neighbourhood Plan.

Should any development sites come forward in the Parish through a site selection and allocation process, these could be reviewed through a Site Assessment package that AECOM can offer, the NPSG may also want to consider developing a masterplan. This will capture and reflect local opinion on appropriate housing densities and layouts, as well as provide more certainty for preferred development sites within the Neighbourhood Area.

As well as providing certainty to the local community, the design codes in this document should give more certainty to developers, as they will be able to design a scheme that is reflective of community aspirations, potentially speeding up the planning application process.

In addition to the guidance set out in this document, future developers should also make sure that they have observed the guidance in the Ministry of Housing, Communities & Local Government's National Design Guide. Developers should also note that housing developments of any size should strive to achieve carbon neutrality in line with the Government's forthcoming Future Homes Standard.

Further standards on residential developments should also be obtained from Building for a Healthy Life, a government-endorsed industry standard for well-designed homes and neighbourhoods.

<b>Actors</b>	<b>How They Will Use the Design Guidelines</b>
<b>Applicants, developers, and landowners</b>	As a guide to community and Local Planning Authority expectations on design, allowing a degree of certainty – they will be expected to follow the Guidelines as planning consent is sought.
<b>Local Planning Authority</b>	As a reference point, embedded in policy, against which to assess planning applications.  The Design Guidance and Codes should be discussed with applicants during any pre-application discussions.
<b>Parish Council</b>	As a guide when commenting on planning applications, ensuring that the Design Guidance and Codes are complied with.
<b>Community organisations</b>	As a tool to promote community-backed development and to inform comments on planning applications.
<b>Statutory consultees</b>	As a reference point when commenting on planning applications.

## About AECOM

AECOM is the world's trusted infrastructure consulting firm, delivering professional services throughout the project lifecycle — from planning, design and engineering to program and construction management. On projects spanning transportation, buildings, water, new energy and the environment, our public- and private-sector clients trust us to solve their most complex challenges. Our teams are driven by a common purpose to deliver a better world through our unrivaled technical expertise and innovation, a culture of equity, diversity and inclusion, and a commitment to environmental, social and governance priorities. AECOM is a *Fortune 500* firm and its Professional Services business had revenue of \$13.2 billion in fiscal year 2020. See how we are delivering sustainable legacies for generations to come at [aecom.com](https://www.aecom.com) and [@AECOM](https://twitter.com/AECOM).